

TEST REPORT

ETSI EN 301 489-1 V2.2.3 (2019-11)

ETSI EN 301 489-3 V2.3.2 (2023-01)

EN 55032:2015 + A1:2020 + A11:2020

EN 55035:2017 + A11:2020

EN IEC 61000-3-2:2019+A1:2021

EN 61000-3-3:2013 + A2:2021

for

Samsung Galaxy watch Charger Mobileparts

Models: MS-30016

Prepared for : 2Service B.V.

Address: Santkamp 5, 6836 BE, Arnhem, The Netherlands

Prepared By : Shenzhen NCT Testing Technology Co., Ltd.

Address: A101&2FB2, Fuqiao 6th Area, Xintian Community,

Fuhai Street, Baoan District, Shenzhen, China

Telephone: +86-400-8868-419

Fax: +86-755-27790922

Date of Test: Dec. 25, 2023 to Jan. 17, 2024

Date of Report: Jan. 17, 2024

Report Number: NCT240031435XE2-2

1 TEST RESULT CERTIFICATION

Applicant : 2Service B.V.
Address : Santkamp 5, 6836 BE, Arnhem, The Netherlands
Manufacturer : 2Service B.V.
Address : Santkamp 5, 6836 BE, Arnhem, The Netherlands
Product name : Samsung Galaxy watch Charger Mobileparts
Model name : MS-30016

The above-mentioned device is tested by NCT to determine the maximum emission level produced by the device and the severity level that the device can withstand and its performance standards. The measurement results are contained in this test report. In addition, this report shows that EUT (equipment under test) technically meets the requirements of EN301489-1 and EN301489-3

This report only applies to the above-mentioned test samples, and cannot be partially copied or modified without written approval by NCT

Date of Test

Date (s) of performance of tests: Dec. 25, 2023 to Jan. 17, 2024

Date of Issue: Jan. 17, 2024

Test Result: Pass

Test Engineer:

Keven Wu

Keven Wu

Technical Manager:

Henry Wan

Henry Wan



Contents

	Page
1 TEST RESULT CERTIFICATION	2
2 TEST SUMMARY	4
3 GENERAL INFORMATION	5
3.1 GENERAL DESCRIPTION OF E.U.T.	5
3.2 DESCRIPTION OF SUPPORT UNITS	5
4 EQUIPMENT DURING TEST	6
4.1 MEASUREMENT UNCERTAINTY	9
5 EMC REQUIREMENTS FOR EMISSIONS	10
5.1 CONDUCTED EMISSIONS	11
5.2 RADIATED EMISSIONS	14
6 HARMONICS CURRENT MEASUREMENT	18
7 VOLTAGE FLUCTUATION AND FLICKS MEASUREMENT	20
8 EMC REQUIREMENT FOR IMMUNITY	21
8.1 PERFORMANCE CRITERIA DESCRIPTION	22
8.2 ELECTROSTATIC DISCHARGE(ESD)	25
8.3 RADIATED IMMUNITY(R/S)	27
8.4 ELECTRICAL FAST TRANSIENTS (EFT)	29
8.5 SURGES	30
8.6 CONDUCTED IMMUNITY 0.15MHZ TO 80MHZ	31
8.7 VOLTAGE DIPS AND INTERRUPTIONS	32
9 PHOTOGRAPHS OF TEST SETUP	33
10 PHOTOGRAPHS OF EUT	35

2 Test Summary

Emission			
ETSI EN 301 489-1 V2.2.3 (2019-11), ETSI EN 301 489-3 V2.3.2 (2023-01)			
EN 55032:2015 + A1:2020 + A11:2020, EN 55035:2017 + A11:2020			
EN IEC 61000-3-2:2019+A1:2021, EN 61000-3-3:2013 + A2:2021			
Test Item	Standard	Limit	Result
Conducted Emissions	EN 55032	Clause 5	PASS
Radiated Emissions	EN 55032	Clause 5	PASS
Harmonic Current Emissions	EN 61000-3-2	Class A	N/A
Voltage Fluctuations and Flicker	EN 61000-3-3	Clause 5	N/A
Immunity			
Test Item	Basic Standard	Limit	Result
Electrostatic Discharge (ESD)	IEC 61000-4-2	B	PASS
Radio-Frequency, Continuous Radiated Disturbance	IEC 61000-4-3	A	PASS
EFT/B Immunity	IEC 61000-4-4	B	N/A
Surge Immunity	IEC 61000-4-5	B	N/A
Conducted RF Immunity	IEC 61000-4-6	A	N/A
Power Frequency Magnetic Field	IEC 61000-4-8	A	N/A
Voltage Dips, >95% Reduction	IEC 61000-4-11	B	N/A
Voltage Dips, 30% Reduction		C	N/A
Voltage Interruptions		C	N/A
Note: N/A is an abbreviation for Not Applicable.			

3 General Information

3.1 General Description of E.U.T.

Product:	Samsung Galaxy watch Charger Mobileparts
Model Number:	MS-30016
Different:	N/A
Rating:	Type-c Input: 5Vdc,1A Wireless Output :5W
Frequency Range:	145.6KHz
Modulation Technique:	Induction
Antenna Type:	Induction Coil antenna
Antenna Gain:	0 dBm
Temperature Range:	-20°C ~ +55°C

3.2 DESCRIPTION OF SUPPORT UNITS

No.	Equipment	Model	Serial No.	Trade Name
1.	Load	-	-	-

4 Equipment During Test

Conducted emission					
Name	Model No.	Serial No.	Manufacturer	Date of Cal.	Due Date
EMI Test Receiver	ESPI	101604	RS	2023/6/21	2024/6/20
LISN	ENV 216	102796	RS	2023/3/17	2024/3/16
LISN	VN1-13S	004023	CRANAGE	2023/6/21	2024/6/20

Radiated emission					
Name	Model No.	Serial No.	Manufacturer	Date of Cal.	Due Date
EMI Test Receiver	ESCI	101178	RS	2023/6/21	2024/6/20
Spectrum Analyzer	N9020A	MY5051020 2	Agilent	2023/6/21	2024/6/20
Amplifier	BBV 9743 B	00374	SCHWARZBECK	2023/6/21	2024/6/20
Bilog Antenna	VULB9162	00473	SCHNARZBECK	2023/3/19	2025/3/18
Horn antenna	BBHA 9120 D	02622	SCHNARZBECK	2023/3/19	2024/3/18
Preamplifier	BBV 9718D	00042	SCHNARZBECK	2023/6/21	2024/6/20

Harmonic & Flicker					
Name	Model No.	Serial No.	Manufacturer	Date of Cal.	Due Date
Harmonics Flicker Test System	AC200A	512369	LAPLACE	2023/6/21	2024/6/20

Electrostatic Discharge					
Name	Model No.	Serial No.	Manufacturer	Date of Cal.	Due Date
Electostastic Discharge Generator	HESD 16	006315	HTEC	2023/6/26	2024/6/25

Continuous radiated disturbances(HUAK)					
Name	Model No.	Serial No.	Manufacturer	Date of Cal.	Due Date
Signal generator	83630A	HKE-028	Agilent	2023/6/21	2024/6/20
Hr antenna	LB-180400-KF	HKE-031	Schwarzbeck	2023/3/19	2024/3/17
Power amplifier	NTWPA-1060040E	HKE-035	RS	2023/6/21	2024/6/20
Broadband antenna	VULB 9163	HKE-012	Schwarzbeck	2023/6/21	2024/6/20
Power anplifier	5225F	HKE-058	RS	2023/3/19	2024/3/17

EFT/Dip					
Name	Model No.	Serial No.	Manufacturer	Date of Cal.	Due Date
Fast Transient Burst Simulator	HCOM PACT52	221003	HTEC	2023/6/21	2024/6/20
CYCLE SAG SIMULATOR	HV1P16T	221302	HTEC	2023/6/21	2024/6/20

Continuous conducted disturbances					
Name	Model No.	Serial No.	Manufacturer	Date of Cal.	Due Date
Signal Generator	CDG-7000-25	10904-1	SCHLODER	2023/6/21	2024/6/20
Power Amplifier	CDG 6050-100	191103	SCHLODER	2023/6/21	2024/6/20
CDN	M2+3	210319	SCHLODER	2023/6/21	2024/6/20

Power-frequency Magnetic field					
Name	Model No.	Serial No.	Manufacturer	Date of Cal.	Due Date
Continuous Wave Simulator	HMFG100	212305	HTEC	2023/6/21	2024/6/20

Surge					
Name	Model No.	Serial No.	Manufacturer	Date of Cal.	Due Date
Lightning Surge Generator	HOV 7000	222202	HTEC	2023/6/30	2024/6/29
Lightning Surge Generator	HIM 450	222201	HTEC	2023/6/30	2024/6/29
Lightning Surge Generator	SCDN161	222203	HTEC	2023/6/30	2024/6/29

4.1 Measurement Uncertainty

Parameter	Uncertainty
Occupied Channel Bandwidth	±5 %
RF output power, conducted	±1.5dB
Power Spectral Density, conducted	±3dB
Unwanted Emissions, conducted	±3dB
All emissions, radiated	±6dB
Time	±2%
Duty Cycle	±2%
Temperature	±1°C
Humidity	±5%
DC and low frequency voltages	±3%
Conduction disturbance(150kHz~30MHz)	±3.26dB
Radiated Emission(30MHz~1GHz)	±4.73dB
Radiated Emission(1GHz~25GHz)	±5.02dB

5 EMC Requirements for Emissions

(1) Normal Test Conditions:

Ambient Condition: Normal

(2) Extreme Test Conditions:

N/A

(3) Test Configuration

- measurements shall be made in the operational mode producing the largest emission in the frequency band being investigated consistent with normal applications;
- the equipment shall be configured in a manner which is representative for normal/typical operation, where practical;
- where radio equipment is provided with an integral antenna, it shall be tested with the antenna fitted in a manner typical of normal intended use, unless declared as a removable antenna;
- if the equipment is part of a system, or can be connected to ancillary equipment, then it shall be acceptable to test the equipment while connected to the minimum representative configuration of ancillary equipment necessary to exercise the ports;
- if the equipment has a large number of ports, then a sufficient number shall be selected to simulate actual operational conditions and to ensure that all the different types of termination are covered;
- ports, which in normal operation are connected, shall be connected to an ancillary equipment or to a representative piece of cable terminated to simulate the impedance of the ancillary equipment. RF input/output ports shall be correctly terminated;
- the configuration and mode of operation during the measurements shall be precisely noted in the test report.

(4) Test Mode

TM	Charging
----	----------

5.1 Conducted Emissions

Test Requirement	: EN 301 489-3
Test Method	: EN 301 489-1, EN 55032
Frequency Range	: 150kHz to 30MHz
Class/Severity	: Class B/ Table 2 of EN 55032
Detector	: Peak for pre-scan (9kHz Resolution Bandwidth)

5.1.1 E.U.T. Operation

Operating Environment :

Temperature	: 25 °C
Humidity	: 50 % RH
Atmospheric Pressure	: 101.2kPa

5.1.2 Test Setup

The conducted emission tests were performed using the setup accordance with the EN 55022.

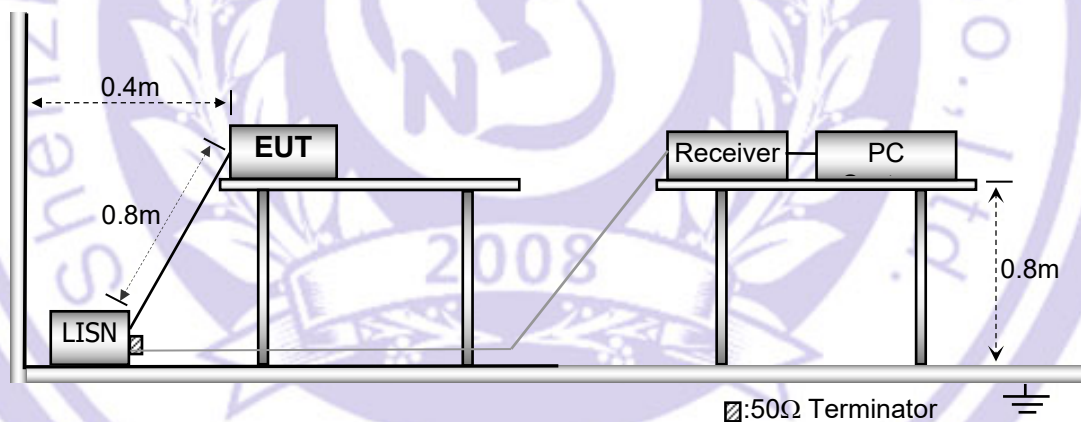

5.1.3 Measurement Description

An initial pre-scan was performed on the live and neutral lines.

No further quasi-peak or average measurements were performed since no peak emissions were detected within 10dB line below the average limit.

5.1.4 Test Results

Test Phase: L

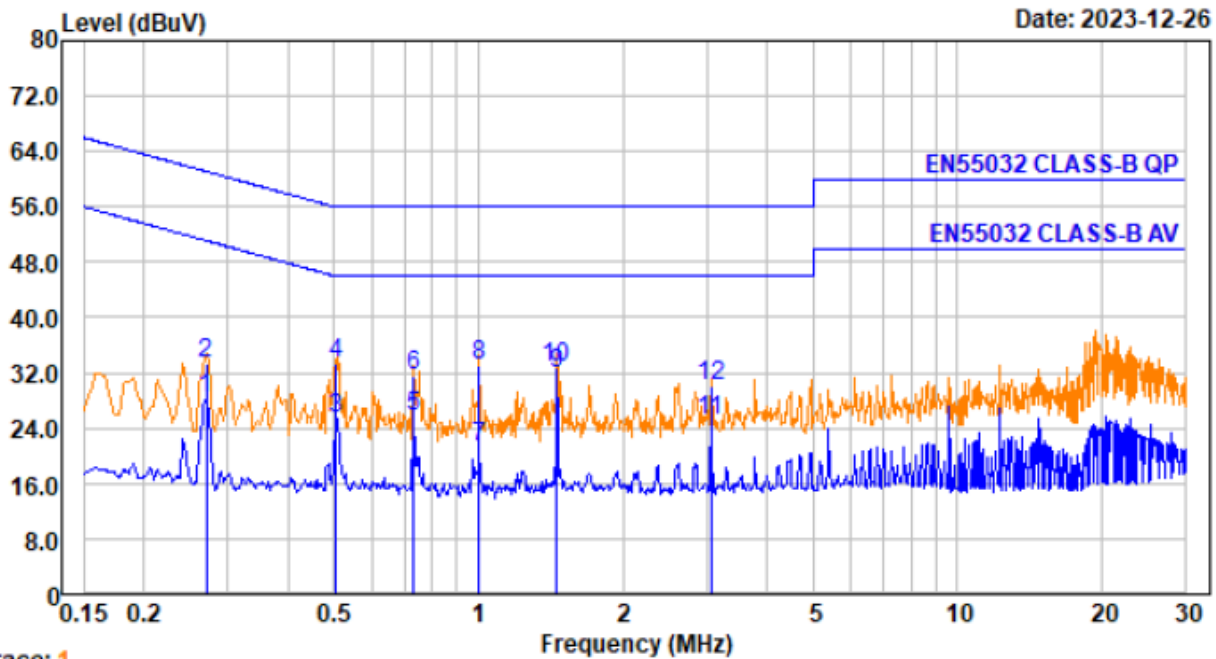

Trace: 1

No.	Freq MHz	Cable Loss dB	LISN Factor dB/m	Receiver Reading dBuV	Emission Level dBuV/m	Limit dBuV/m	Over Limit dB	Remark
1.	0.270	0.01	9.56	8.73	28.44	51.12	-22.68	Average
2.	0.270	0.01	9.56	13.69	33.40	61.12	-27.72	QP
3.	0.505	0.01	9.57	5.65	25.35	46.00	-20.65	Average
4.	0.505	0.01	9.57	13.60	33.30	56.00	-22.70	QP
5.	0.731	0.02	9.58	5.92	25.62	46.00	-20.38	Average
6.	0.731	0.02	9.58	11.90	31.60	56.00	-24.40	QP
7.	1.005	0.02	9.58	1.51	21.20	46.00	-24.80	Average
8.	1.005	0.02	9.58	13.50	33.19	56.00	-22.81	QP
9.	1.456	0.03	9.58	12.25	31.94	46.00	-14.06	Average
10.	1.456	0.03	9.58	13.20	32.89	56.00	-23.11	QP
11.	3.058	0.06	9.59	5.43	25.13	46.00	-20.87	Average
12.	3.058	0.06	9.59	10.40	30.10	56.00	-25.90	QP

Test Phase: N

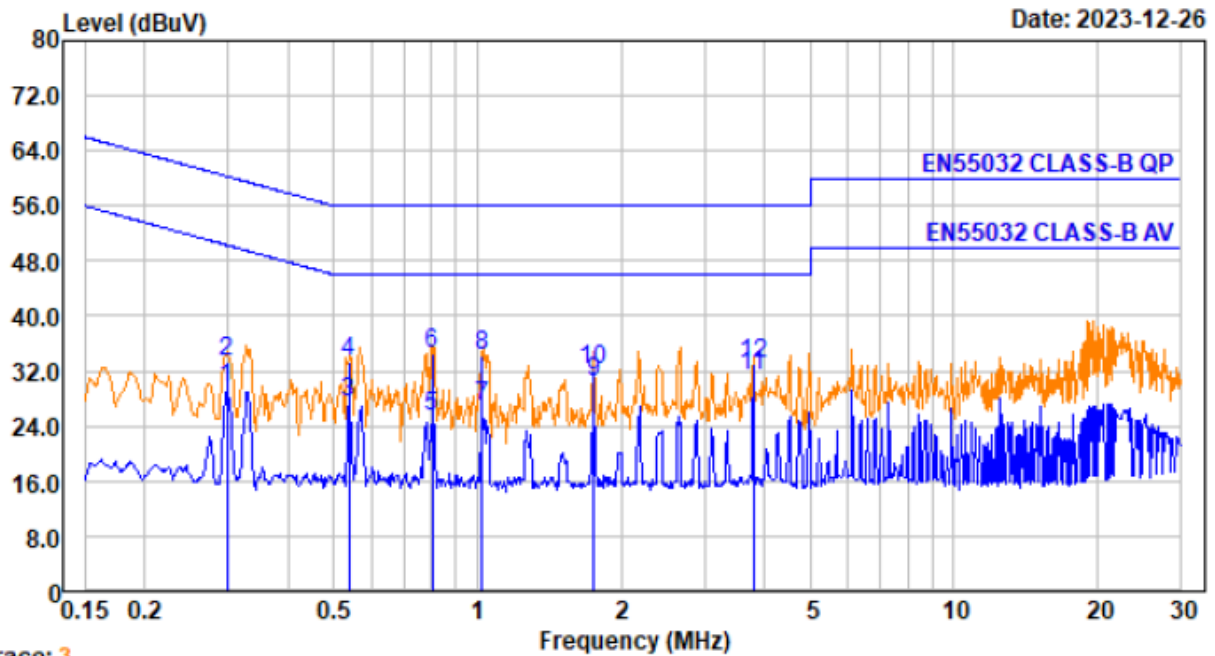

Trace: 3

No.	Freq MHz	Cable Loss dB	LISN Factor dB/m	Receiver Reading dBuV	Emission Level dBuV/m	Limit dBuV/m	Over Limit dB	Remark
1.	0.299	0.01	9.56	9.75	29.45	50.28	-20.83	Average
2.	0.299	0.01	9.56	13.70	33.40	60.28	-26.88	QP
3.	0.538	0.01	9.58	7.78	27.48	46.00	-18.52	Average
4.	0.538	0.01	9.58	13.71	33.41	56.00	-22.59	QP
5.	0.804	0.02	9.58	5.75	25.45	46.00	-20.55	Average
6.	0.804	0.02	9.58	14.70	34.40	56.00	-21.60	QP
7.	1.021	0.02	9.58	7.03	26.72	46.00	-19.28	Average
8.	1.021	0.02	9.58	14.50	34.19	56.00	-21.81	QP
9.	1.753	0.04	9.58	10.65	30.34	46.00	-15.66	Average
10.	1.753	0.04	9.58	12.60	32.29	56.00	-23.71	QP
11.	3.799	0.07	9.63	11.43	31.17	46.00	-14.83	Average
12.	3.799	0.07	9.63	13.39	33.13	56.00	-22.87	QP

5.2 Radiated Emissions

Test Requirement	:	EN 301 489-3
Test Method	:	EN 301 489-1, EN 55032
Frequency Range	:	30MHz to 1GHz, 1GHz to 6GHz
Class/Severity	:	Class B/ Table 6 of EN 55032(30MHz to 1GHz) Class B/ Table 8 of EN 55032(1GHz to 6GHz)
Detector	:	Peak for pre-scan (120kHz Resolution Bandwidth Below 1GHz; 1MHz Resolution Bandwidth Above 1GHz)

5.2.1 EUT Operation

Operating Environment :

Temperature	:	25.5 °C
Humidity	:	51 % RH
Atmospheric Pressure	:	101.2kPa

5.2.2 Test Setup

The radiated emission tests were performed using the setup accordance with the EN 55022.

Frequency Range: Below 1 GHz

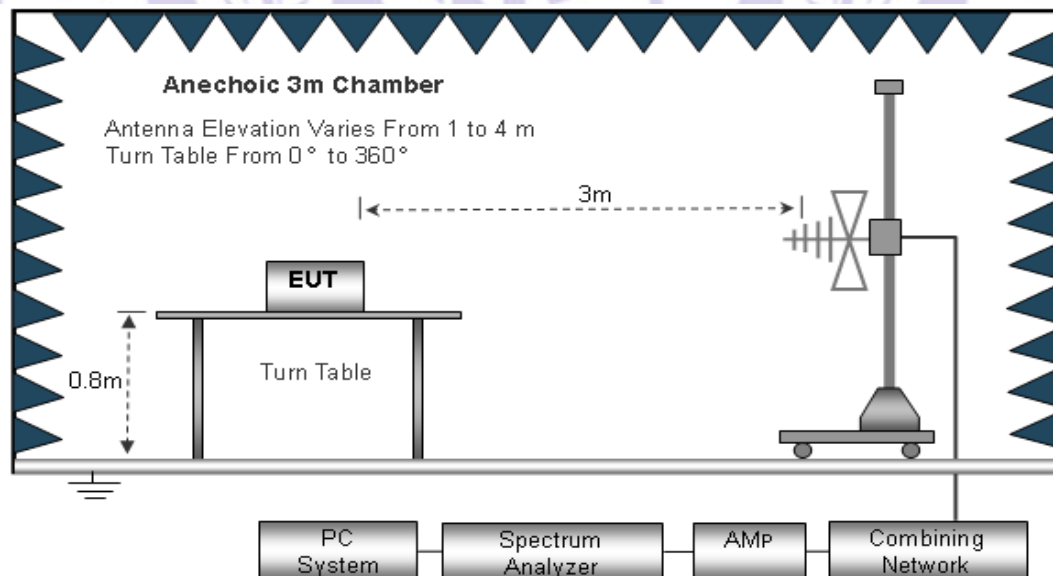

Frequency Range: Above 1 GHz

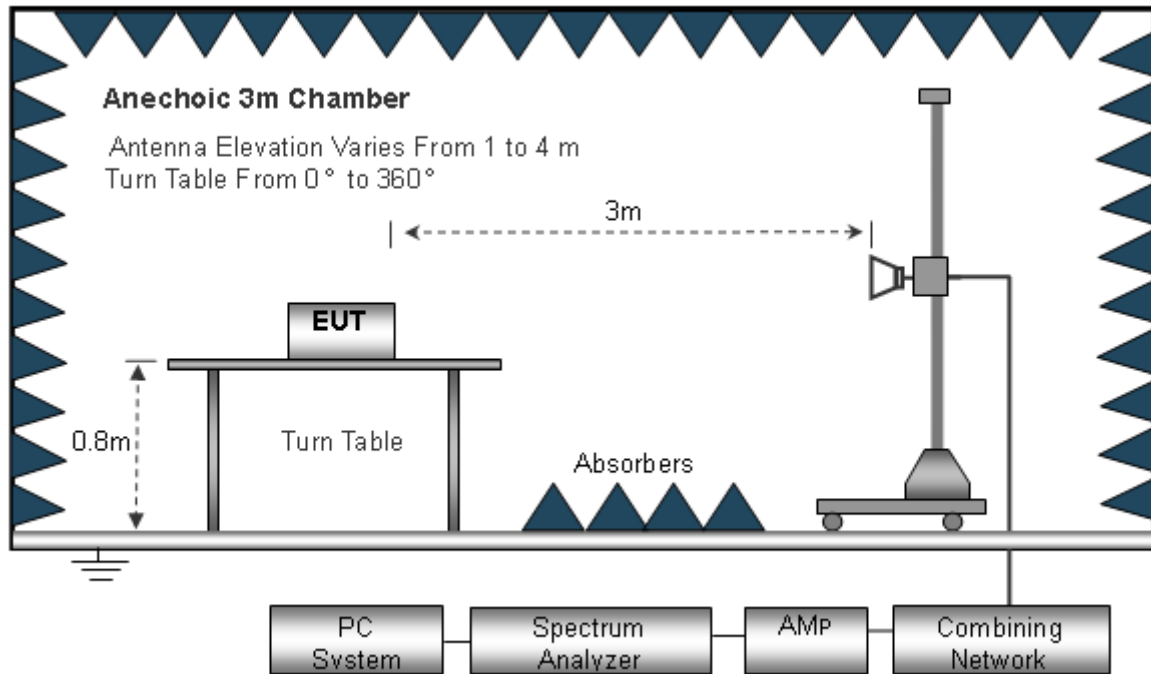

5.2.3 Corrected Amplitude & Margin Calculation

The Corrected Amplitude is calculated by adding the Antenna Factor and Cable Factor, and subtracting the Amplifier Gain from the Amplitude reading. The basic equation is as follows:

$$\text{Corr. Ampl.} = \text{Indicated Reading} + \text{Antenna Factor} + \text{Cable Factor} - \text{Amplifier Gain}$$

The “**Margin**” column of the following data tables indicates the degree of compliance with the applicable limit. For example, a margin of -7dB means the emission is 7dB below the maximum limit for Class B. The equation for margin calculation is as follows:

$$\text{Margin} = \text{Corr. Ampl.} - \text{Class B Limit}$$

5.2.4 Test Result

Frequency Range: 30MHz ~ 1000MHz

Antenna Polarization: Horizontal

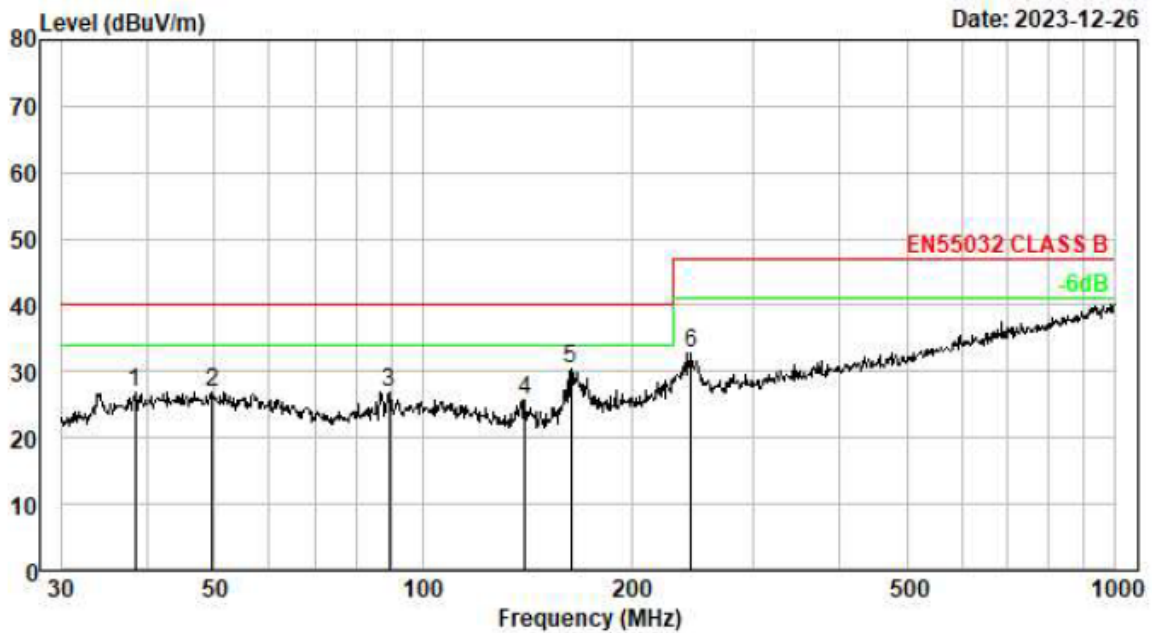

No.	Freq MHz	Cable Loss dB	ANT Factor dB/m	Preamp Gain dB	Receiver Reading dBμV	Emission Level dBμV/m	Limit dBμV/m	Over Limit dB	Remark
1	38.346	0.33	12.07	0.00	14.54	26.94	40.00	-13.06	QP
2	49.707	0.43	12.69	0.00	13.80	26.92	40.00	-13.08	QP
3	89.276	0.65	9.89	0.00	16.32	26.86	40.00	-13.14	QP
4	140.342	0.87	8.49	0.00	16.40	25.76	40.00	-14.24	QP
5	163.755	0.95	8.99	0.00	20.59	30.53	40.00	-9.47	QP
6	244.232	1.17	12.83	0.00	18.89	32.89	47.00	-14.11	QP

Antenna Polarization: Vertical

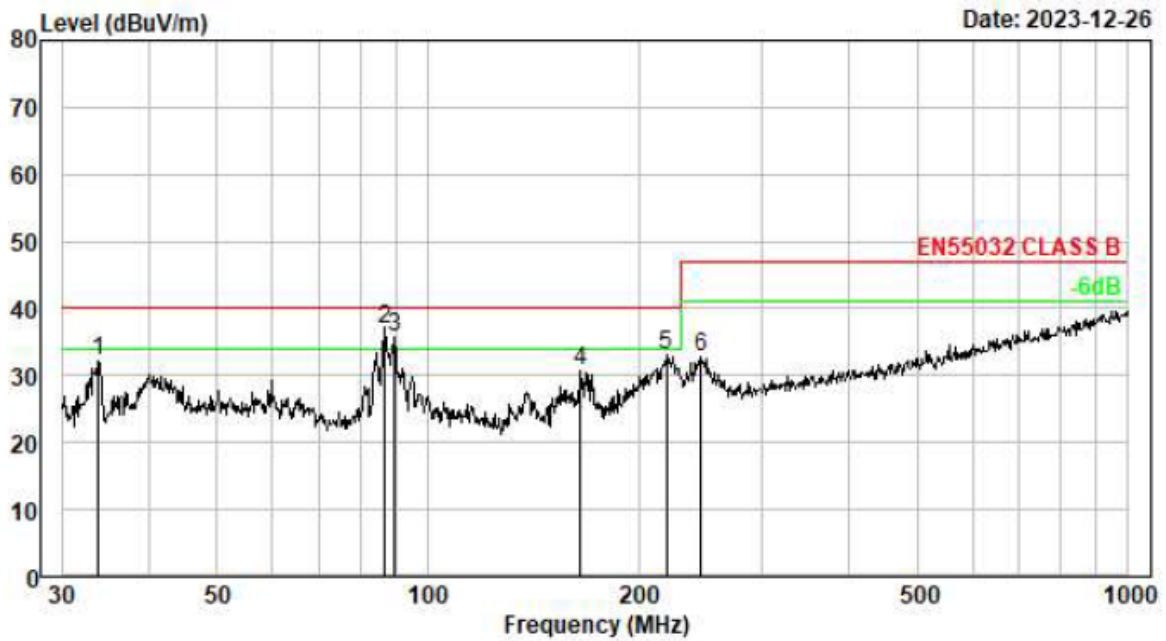

No.	Freq MHz	Cable Loss dB	ANT Factor dB/m	Preamplifier Gain dB	Receiver Reading dBμV	Emission Level dBμV/m	Limit dBμV/m	Over Limit dB	Remark
1	33.799	0.28	10.80	0.00	21.10	32.18	40.00	-7.82	QP
2	86.807	0.64	9.84	0.00	26.40	36.88	40.00	-3.12	QP
3	89.590	0.65	9.89	0.00	25.29	35.83	40.00	-4.17	QP
4	165.487	0.96	9.08	0.00	20.72	30.76	40.00	-9.24	QP
5	219.075	1.11	12.05	0.00	19.92	33.08	40.00	-6.92	QP
6	245.951	1.17	12.88	0.00	18.72	32.77	47.00	-14.23	QP

6 HARMONICS CURRENT MEASUREMENT

6.1 LIMITS OF HARMONICS CURRENT MEASUREMENT

Limit for Class A equipment		Limit for Class D equipment		
Harmonics Order N	Max. permissible harmonics current A	Harmonics Order n	Max. permissible harmonics current per watt mA/W	Max. permissible harmonics current A
Odd harmonics		Odd Harmonics only		
3	2.30	3	3.4	2.30
5	1.14	5	1.9	1.14
7	0.77	7	1.0	0.77
9	0.40	9	0.5	0.40
11	0.33	11	0.35	0.33
13	0.21	13	0.30	0.21
15 ≤ n ≤ 39	0.15x(15/n)	15 ≤ n ≤ 39 (odd harmonics only)	3.85/n	0.15x(15/n)
Even harmonics				
2	1.08			
4	0.43			
6	0.30			
8 ≤ n ≤ 40	0.23x8/n			

Limit for Class C equipment	
Harmonics Order n	Max. permissible harmonics current expressed as a percentage of the input current at the fundamental frequency A
2	2
3	30xF
5	10
7	7
9	5
11 ≤ n < 39 (odd harmonics only)	3

F is the circuit power factor

Note: Class A, B, C and D are classified according to item 7.5.2. of this report

6.2 TEST PROCEDURES

The EUT was placed on the top of a wooden table 0.8 meters above the ground and operated to produce the maximum harmonic. The classification of EUT is according to section 5 of EN IEC61000-3-2.

The EUT is classified as follows:

Class A:

Balanced three-phase equipment, Household appliances excluding equipment as Class D, Tools excluding portable tools, Dimmers for incandescent lamps, audio equipment, equipment not specified in one of the three other classes.

Class B:

Portable tools; Arc welding equipment which is not professional equipment.

Class C:

Lighting equipment

Class D:

Equipment having a specified power less than or equal to 600 W of the following types: Personal computers and personal computer monitors and television receivers.

The correspondent test program of test instrument to measure the current harmonics emanated from EUT is chosen. The measure time shall be not less than the time necessary for the EUT to be exercised.

6.3 TEST SETUP

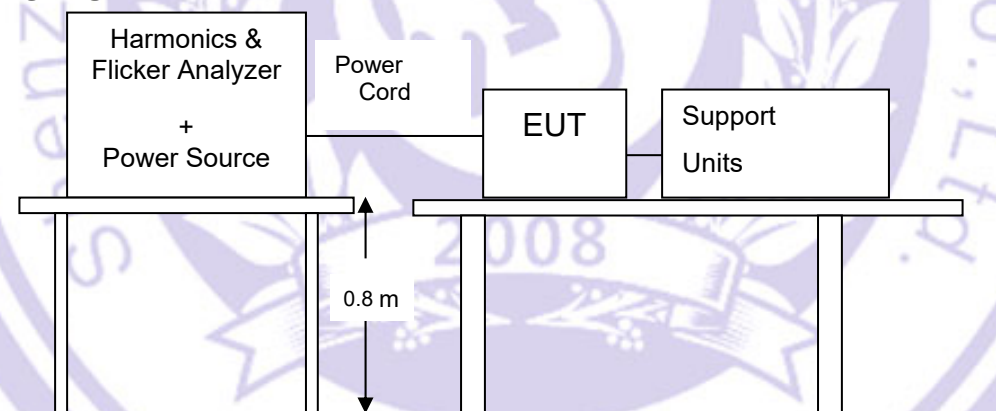

For the actual test configuration, please refer to the related item – Photographs of the Test Configuration.

6.4 TEST RESULT

N/A.

The power of EUT is less than 75W, according to the EN IEC 61000-3-2, it no need to test this item.

7 VOLTAGE FLUCTUATION AND FLICKS MEASUREMENT

7.1 LIMITS OF VOLTAGE FLUCTUATION AND FLICKS MEASUREMENT

TEST ITEM	LIMIT	REMARK
P_{st}	1.0	P_{st} means short-term flicker indicator.
P_{lt}	0.65	P_{lt} means long-term flicker indicator.
T_{dt} (ms)	500	T_{dt} means maximum time that dt exceeds 3 %.
d_{max} (%)	4/6/7 %	d_{max} means maximum relative voltage change.
dc (%)	3.3 %	dc means relative steady-state voltage change

7.2 TEST PROCEDURE

The EUT was placed on the top of a wooden table 0.8 meters above the ground and operated to produce the most unfavorable sequence of voltage changes under lighting operating conditions. During the flick measurement, the measure time shall include that part of whole operation cycle in which the EUT produce the most unfavorable sequence of voltage changes. The observation period for short-term flicker indicator is 10 minutes and the observation period for long-term flicker indicator is 2 hours.

7.3 TEST SETUP

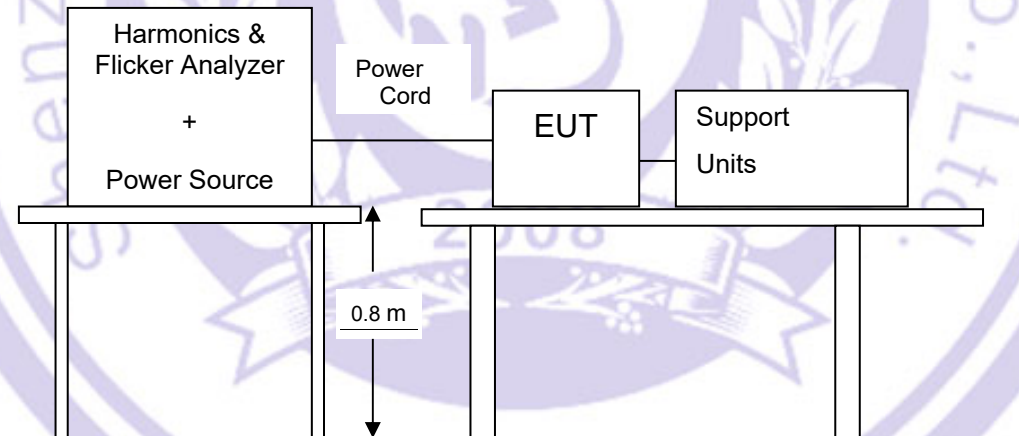

For the actual test configuration, please refer to the related item – Photographs of the Test Configuration.

7.4 TEST RESULT

N/A

8 EMC Requirement for Immunity

(1). Normal Test Conditions:

Ambient Condition: Normal

(2). Extreme Test Conditions:

N/A

(3). Test Configuration

- the tests shall be made in the mode(s) of operation specified in clause 4 in the relevant part of the EN 301 489 series [i.13] dealing with the particular type of radio equipment;
- the tests shall be carried out at a point within the specified normal operating environmental range and at the rated supply voltage for the equipment;
- if the equipment is part of a system, or can be connected to ancillary equipment, then it shall be acceptable to test the equipment connected to the minimum representative configuration of ancillary equipment necessary to exercise the ports;
- where radio equipment is provided with an integral antenna, it shall be tested with the antenna fitted in a manner typical of normal intended use, unless declared as a removable antenna;
- for the immunity tests of ancillary equipment, without a separate pass/fail criteria, the receiver or transmitter coupled to the ancillary equipment, shall be used to judge whether the ancillary equipment passes or fails;
- if the equipment has a large number of ports, then a sufficient number shall be selected to simulate actual operational conditions and to ensure that all the different types of termination are covered;
- ports, which in normal operation are connected, shall be connected to an ancillary equipment or to a representative piece of cable terminated to simulate the impedance of the ancillary equipment. RF input/output ports shall be correctly terminated;
- ports which are not connected to cables during normal intended operation, e.g. service connectors, programming connectors, temporary connectors etc. shall not be connected to any cables for the purpose of EMC testing. Where cables have to be connected to these ports, or interconnecting cables have to be extended in length in order to exercise the Equipment Under Test (EUT), precautions shall be taken to ensure that the evaluation of the EUT is not affected by the addition or extension of these cables;
- the configuration and mode of operation during the tests shall be precisely noted in the test report.

(4). Test Mode

TM	Charging
----	----------

8.1 Performance Criteria Description

EN 301 489-1 Clause 6 requirements:

The performance criteria are used to take a decision on whether a radio equipment passes or fails immunity tests.

For the purpose of the present document four categories of performance criteria apply:

- performance criteria for continuous phenomena applied to transmitters(CT);
- performance criteria for transient phenomena applied to transmitters(TT);
- performance criteria for continuous phenomena applied to receivers(CR);
- performance criteria for transient phenomena applied to receivers(TR).

Normally, the performance criteria depend on the type of radio equipment. Thus, the present document only contains general performance criteria commonly used for the assessment of radio equipment. More specific and product-related performance criteria for a dedicated type of radio equipment may be found in the part of EN 301 489 series [i.13] dealing with the particular type of radio equipment.

Performance Criteria	Description
CT	<p>The performance criteria A shall apply.</p> <p>Tests shall be repeated with the EUT in standby mode (if applicable) to ensure that unintentional transmission does not occur. In systems using acknowledgement signals, it is recognized that an ACKnowledgement (ACK) or Not ACKnowledgement (NACK) transmission may occur, and steps should be taken to ensure that any transmission resulting from the application of the test is correctly interpreted.</p>
TT	<p>The performance criteria B shall apply, except for voltage dips of 100 ms and voltage interruptions of 5 000 ms duration, for which performance criteria C shall apply.</p> <p>Tests shall be repeated with the EUT in standby mode (if applicable) to ensure that unintentional transmission does not occur. In systems using acknowledgement signals, it is recognized that an acknowledgement (ACK) or not-acknowledgement (NACK) transmission may occur, and steps should be taken to ensure that any transmission resulting from the application of the test is correctly interpreted.</p>
CR	<p>The performance criteria A shall apply.</p> <p>Where the EUT is a transceiver, under no circumstances, shall the transmitter operate unintentionally during the test. In systems using acknowledgement signals, it is recognized that an ACK or NACK transmission may occur, and steps should be taken to ensure that any transmission resulting from the application of the test is correctly interpreted.</p>

TR	<p>The performance criteria B shall apply, except for voltage dips of 100 ms and voltage interruptions of 5 000 ms duration for which performance criteria C shall apply.</p> <p>Where the EUT is a transceiver, under no circumstances, shall the transmitter operate unintentionally during the test. In systems using acknowledgement signals, it is recognized that an ACK or NACK transmission may occur, and steps should be taken to ensure that any transmission resulting from the application of the test is correctly interpreted.</p>
----	---



EN 301 489-3 Clause 6 requirements:

The performance criteria are:

- performance criteria A for immunity tests with phenomena of a continuous nature;
- performance criteria B for immunity tests with phenomena of a transient nature;
- performance criteria C for immunity tests with power interruptions exceeding a certain time.

The equipment shall meet the minimum performance criteria as specified in the following clauses.

Criteria	During test	After test
A	Shall operate as intended. May show degradation of performance (see note 1). Shall be no loss of function. Shall be no unintentional transmissions.	Shall operate as intended. Shall be no degradation of performance (see note 2). Shall be no loss of function. Shall be no loss of stored data or user programmable functions.
B	May show loss of function (one or more). May show degradation of performance (see note 1). No unintentional transmissions.	Functions shall be self-recoverable. Shall operate as intended after recovering. Shall be no degradation of performance (see note 2). Shall be no loss of stored data or user programmable functions.
C	May be loss of function (one or more).	Functions shall be recoverable by the operator. Shall operate as intended after recovering. Shall be no degradation of performance (see note 2).

NOTE 1: Degradation of performance during the test is understood as a degradation to a level not below a minimum performance level specified by the manufacturer for the use of the apparatus as intended. In some cases the specified minimum performance level may be replaced by a permissible degradation of performance.

If the minimum performance level or the permissible performance degradation is not specified by the manufacturer then either of these may be derived from the product description and documentation (including leaflets and advertising) and what the user may reasonably expect from the apparatus if used as intended.

NOTE 2: No degradation of performance after the test is understood as no degradation below a minimum performance level specified by the manufacturer for the use of the apparatus as intended. In some cases the specified minimum performance level may be replaced by a permissible degradation of performance. After the test no change of actual operating data or user retrievable data is allowed. If the minimum performance level or the permissible performance degradation is not specified by the manufacturer then either of these may be derived from the product description and documentation (including leaflets and advertising) and what the user may reasonably expect from the apparatus if used as intended.

8.2 Electrostatic Discharge(ESD)

Test Requirement	:	EN 301 489-3
Test Method	:	EN 301 489-1, EN 61000-4-2
Discharge Impedance	:	330 Ω / 150 pF
Discharge Voltage	:	Air Discharge: +/-2,4,8 KV Contact Discharge: +/-2,4 kV HCP & VCP: +/-2,4 kV
Polarity	:	Positive & Negative
Discharge Repeat Times	:	At Least 20 times at each test point
Discharge Mode	:	Single Discharge
Discharge Period	:	1 second minimum

8.2.1 E.U.T. Operation

Operating Environment:	
Temperature	: 24.2°C
Humidity	: 54.5% RH
Barometric Pressure	: 101.1kPa

8.2.2 Block Diagram of Setup

The ESD test was performed in accordance with the EN 61000-4-2.

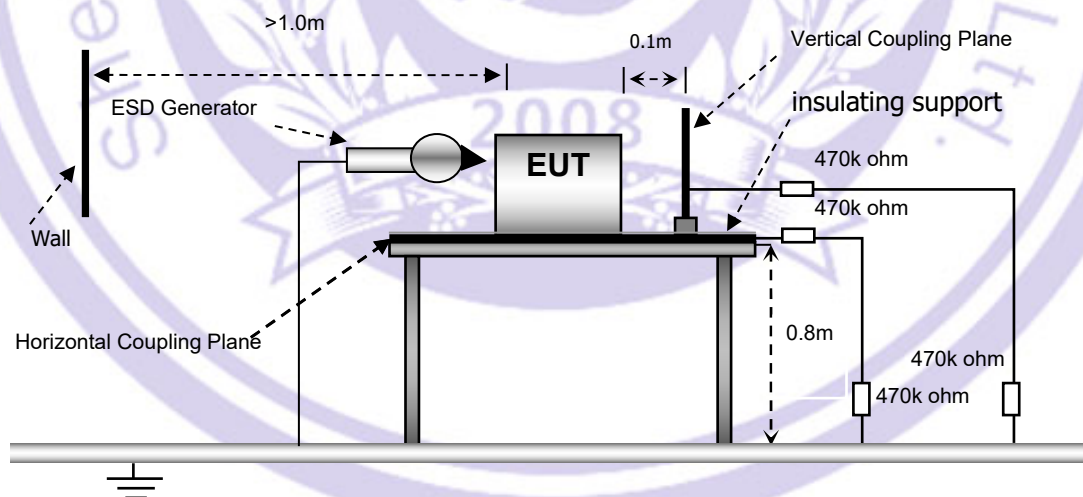

8.2.3 Test Results

Indirect Application			Performance Criteria	
Discharge Level (kV)	Polarity (+/-)	Test Point	Horizontal Coupling	Vertical Coupling
2,4	+/-	1	CT/CR	CT/CR
Remark: Test points : 1. All sides(Front/Top/ Back/ Left/Right Sides).				

Direct Application			Performance Criteria	
Discharge Level (kV)	Polarity (+/-)	Test Point	Contact Discharge	Air Discharge
2,4,8	+/-	2	N/A	TT/TR
2,4	+/-	1	TT/TR	N/A
Remark: Test points : 1. All Exposed Surface & Seams; 2. All metallic part N/A: Not applicable.				

8.3 Radiated Immunity(R/S)

Test Requirement	:	EN 301 489-3
Test Method	:	EN 301 489-1, EN 61000-4-3
Face Under Test	:	Three Mutually Orthogonal Faces
Severity	:	3V/m, 1kHz, 80% Amp. Mod. from 80MHz to 1GHz, 1GHz to 6GHz
Test Result	:	PASS

8.3.1 E.U.T. Operation

Operating Environment:

Temperature	:	24.2°C
Humidity	:	54.5% RH
Barometric Pressure	:	101.1kPa

8.3.2 Block Diagram of Setup

The Radiated Immunity test was performed in accordance with the EN 61000-4-3.

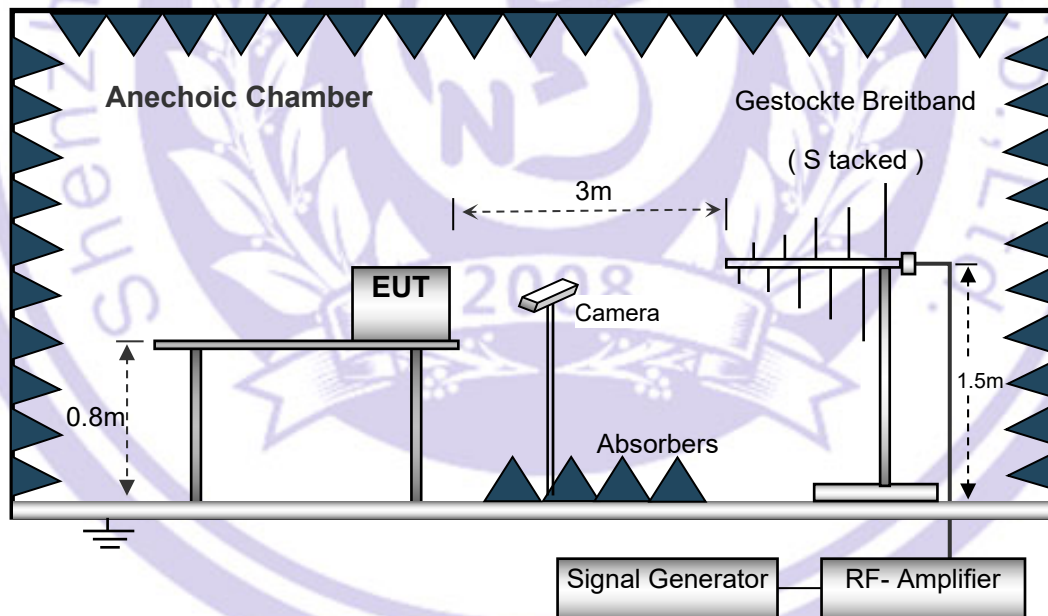

8.3.3 Test Results

Pass.

This item is outsourced from Guangdong Dongguan Quality Supervision Testing Center.

Frequency	Level	Modulation	ANT. Polarization	EUT Face	Performance Criteria
80MHz -1GHz	3V/m	1kHz, 80%, Amp. Mod.	Horizontal/ Vertical	Front, Back Left, Right	CT/CR
1GHz - 6GHz	3V/m	1kHz, 80%, Amp. Mod.	Horizontal/ Vertical	Front, Back Left, Right	CT/CR

8.4 Electrical Fast Transients (EFT)

Test Requirement	:	EN 301 489-3
Test Method	:	EN 301 489-1, EN 61000-4-4
Polarity	:	Positive & Negative
Repetition Frequency	:	5kHz
Burst Duration	:	300ms
Test Duration	:	2 minutes per level & polarity

8.4.1 E.U.T. Operation

Operating Environment:	
Temperature	: 24.2°C
Humidity	: 54.5% RH
Barometric Pressure	: 101.1kPa

8.4.2 Block Diagram of Test Setup

The Electrical Fast Transients Immunity test was performed in accordance with the EN 61000-4-4.

For AC Mains or DC Ports:

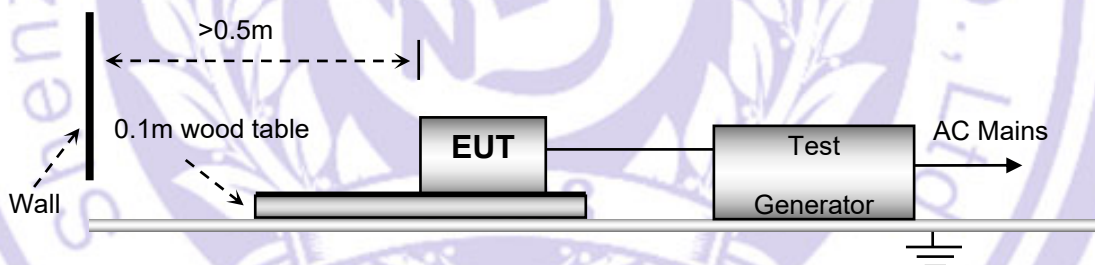

For Signal, Telecommunication or Control Ports:

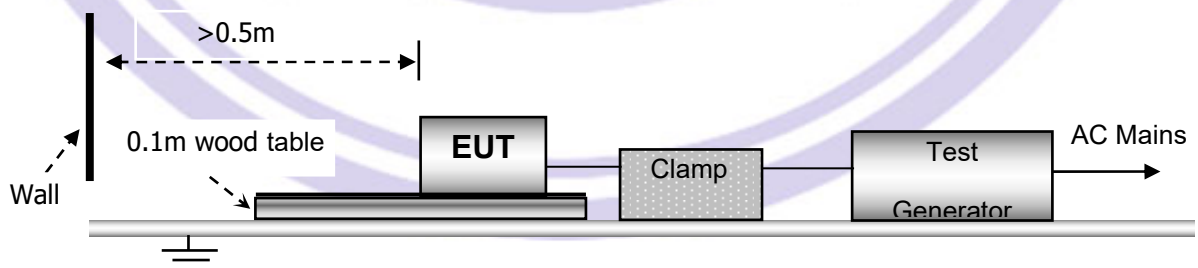

8.4.3 Test Results

N/A

8.5 Surges

Test Requirement	:	EN 301 489-3
Test Method	:	EN 301 489-1, EN 61000-4-5
Interval	:	60s between each surge
No. of surges	:	5 positive, 5 negative at 0°, 90°, 180°, 270°.

8.5.1 E.U.T. Operation

Operating Environment:	
Temperature	: 24.2°C
Humidity	: 54.5% RH
Barometric Pressure	: 101.1kPa

8.5.2 Block Diagram of Test Setup

The Surges Immunity test was performed in accordance with the EN 61000-4-5.

For AC Mains or DC Ports:

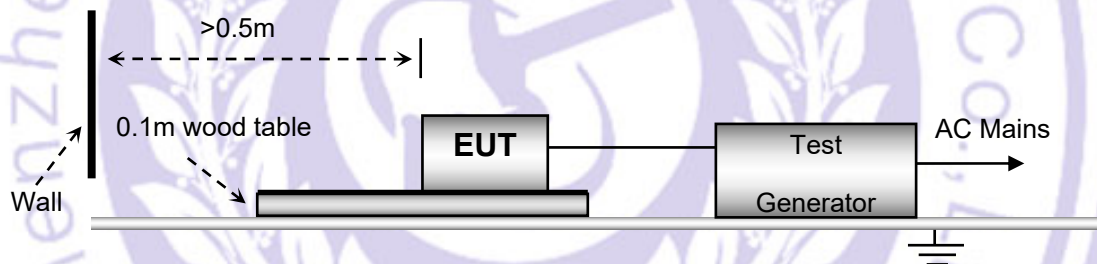

For Telecommunication Port:

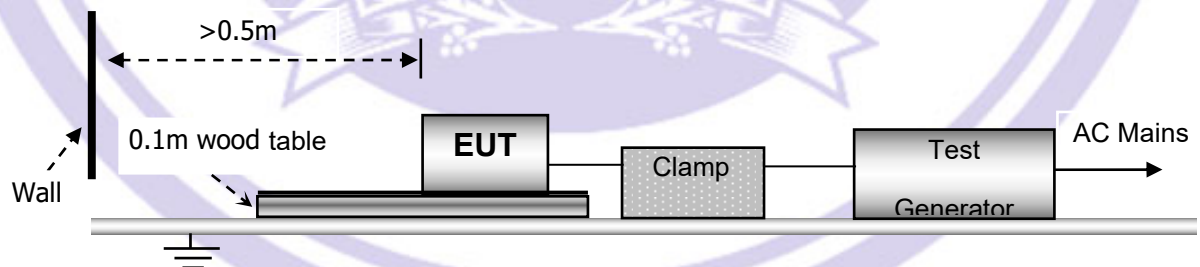

8.5.3 Test Results

N/A

8.6 Conducted Immunity 0.15MHz to 80MHz

Test Requirement	: EN 301 489-3
Test Method	: EN 301 489-1, EN 61000-4-6
Test level	: 3V rms (unmodulated emf into 150 Ω)
Modulation	: 80%, 1kHz Amplitude Modulation.

8.6.1 E.U.T. Operation

Operating Environment :

Temperature	: 24.2°C
Humidity	: 54.5% RH
Barometric Pressure	: 101.1kPa

8.6.2 Block Diagram of Test Setup

The Injected Currents Immunity test was performed in accordance with the EN 61000-4-6.

For AC Mains or DC Ports:

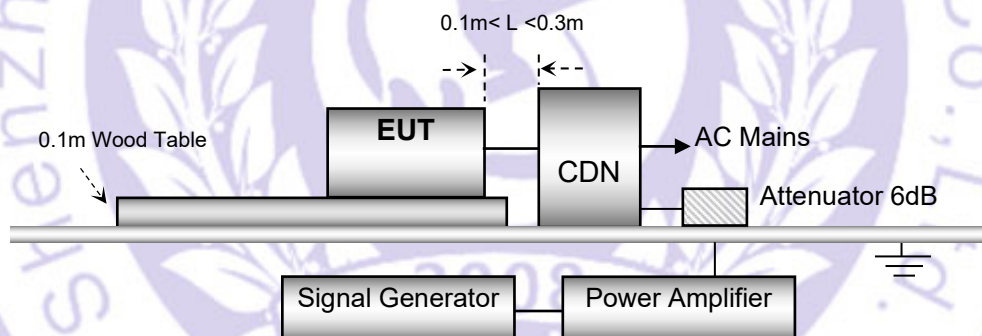

For Signal, Telecommunication or Control Ports:

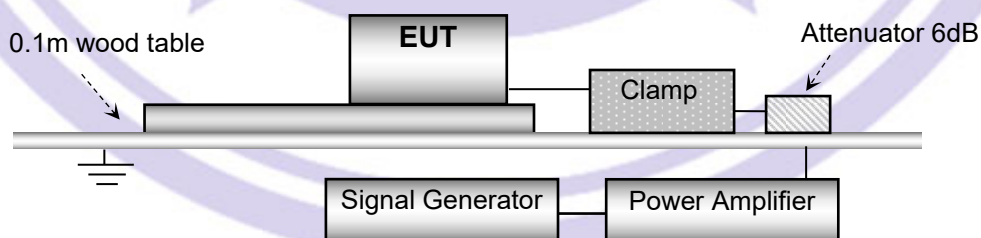

8.6.3 Test Results

N/A

8.7 Voltage Dips and Interruptions

Test Requirement : EN 301 489-3
Test Method : EN 301 489-1, EN 61000-4-11
No. of Dips / Interruptions : 3 per Level at 10ms intervals

8.7.1 E.U.T. Operation

Operating Environment:

Temperature : 24.2°C
Humidity : 54.5% RH
Barometric Pressure : 101.1kPa

8.7.2 Block Diagram of Setup

The Voltage Dips and Interruptions Immunity test was performed in accordance with the EN 61000-4-11.

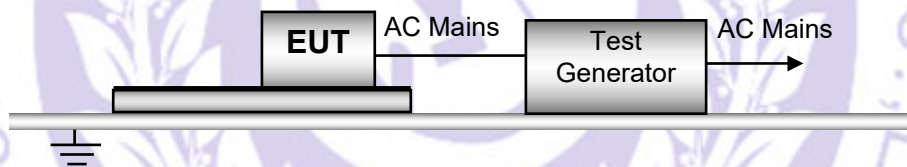

8.7.3 Test Results

N/A

9 PHOTOGRAPHS OF TEST SETUP

RE

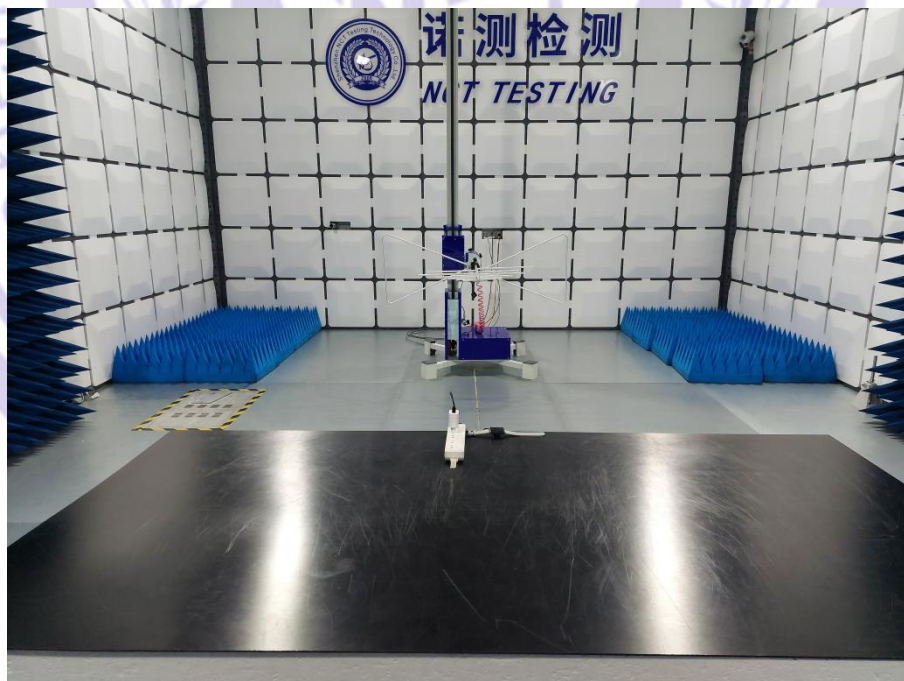
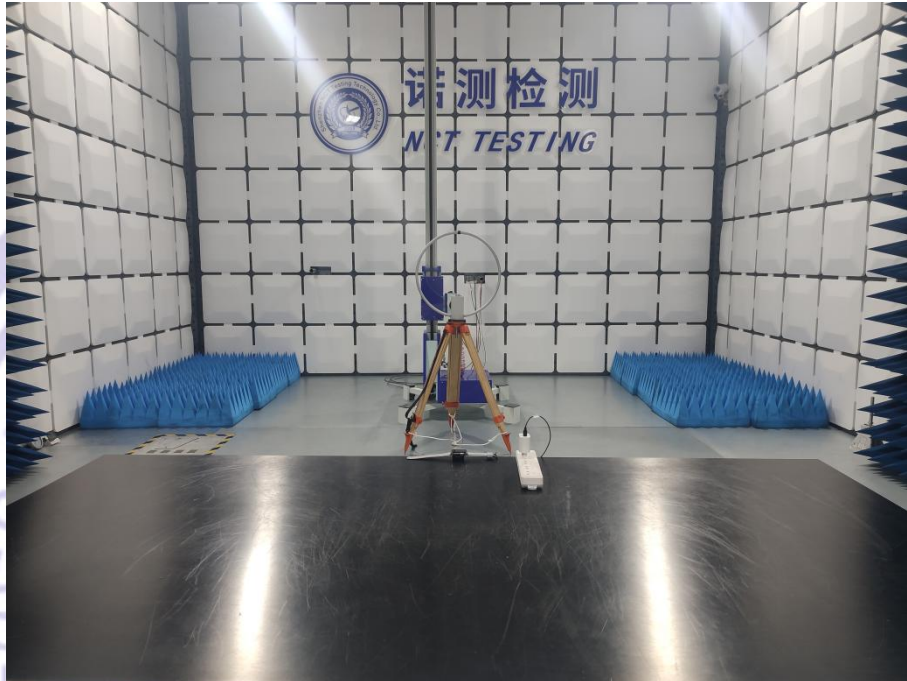

CE



ESD



10 PHOTOGRAPHS OF EUT

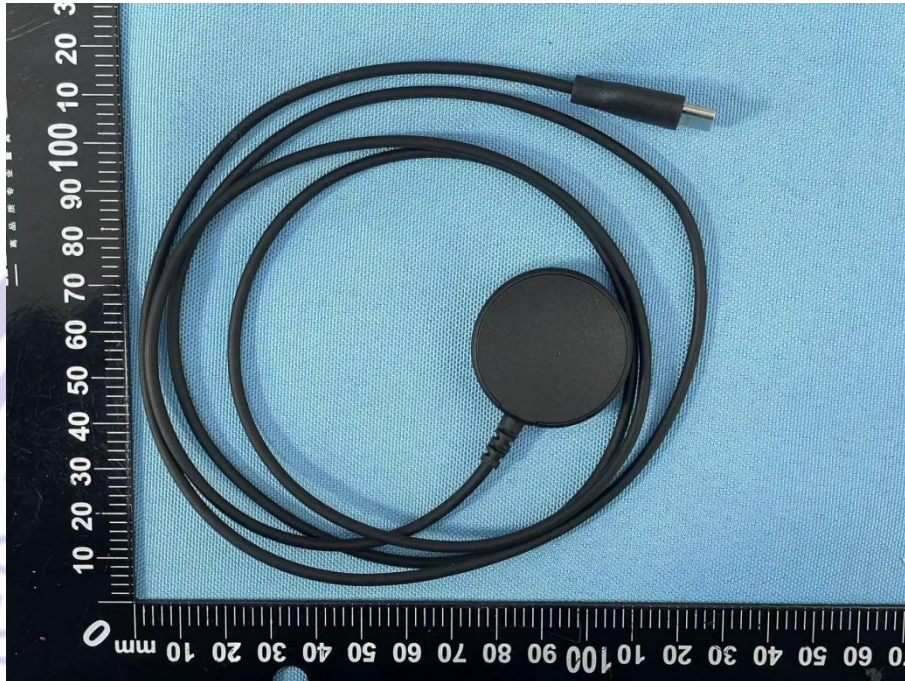



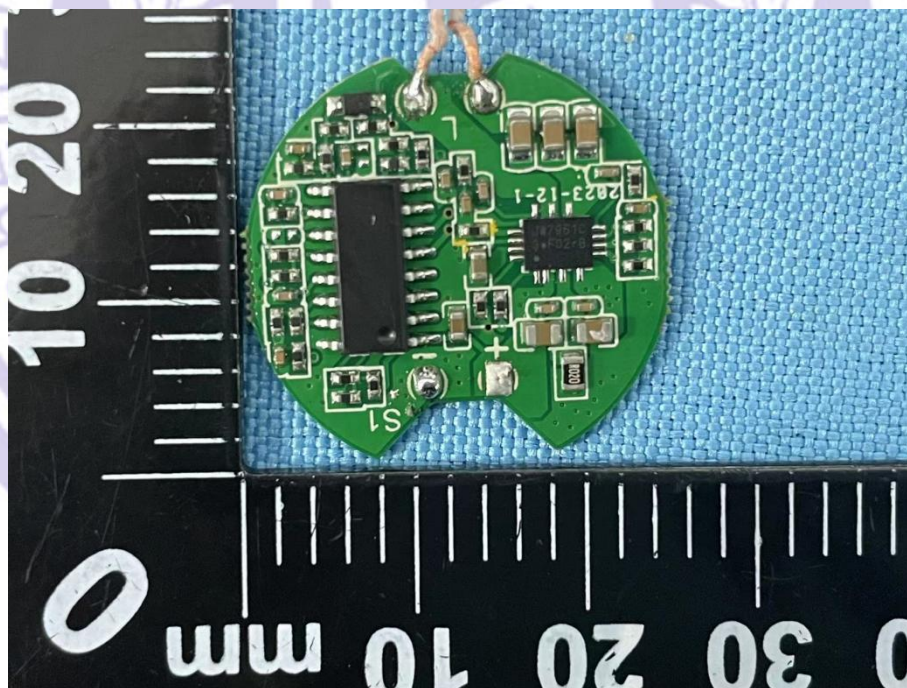
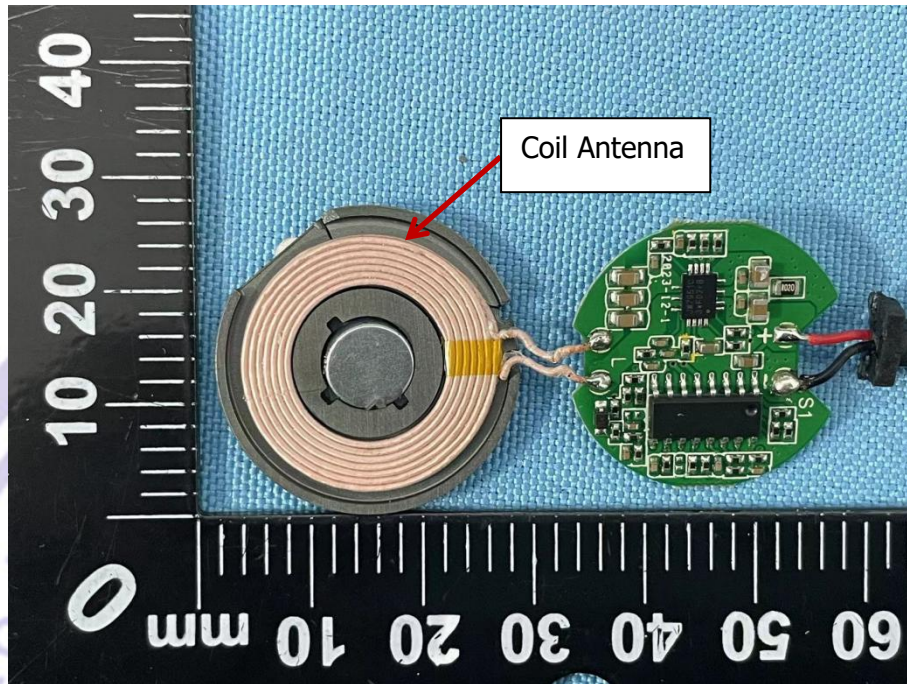

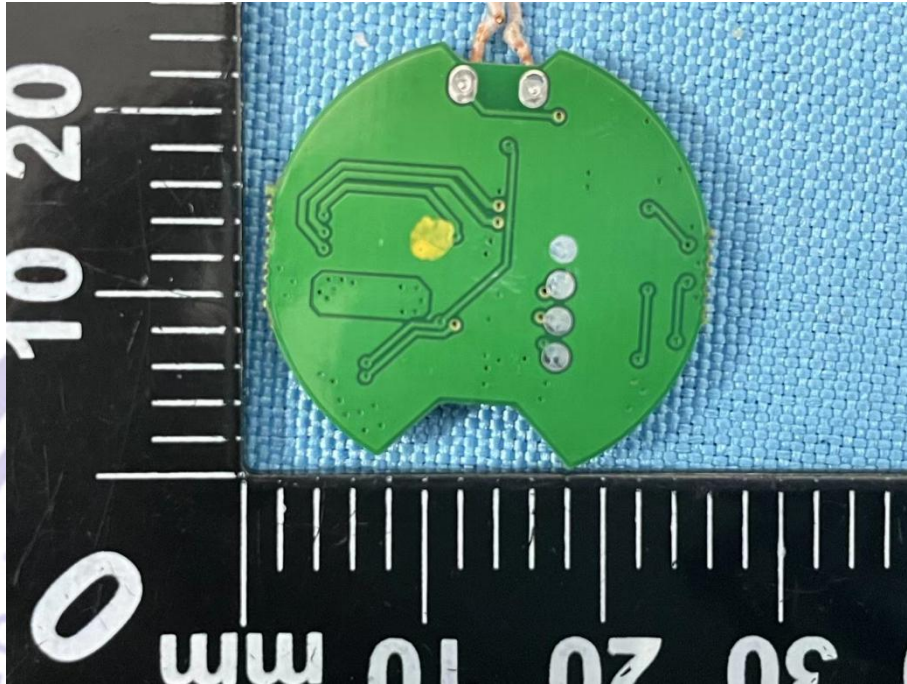

*****THE END REPORT*****