

TEST REPORT

ETSI EN 303 417 V1.1.1: 2017

For
Samsung Galaxy watch
Charger Mobileparts
Models:MS-30016

Prepared for : 2Service B.V.

Address: Santkamp 5, 6836 BE, Arnhem, The Netherlands

Prepared By : Shenzhen NCT Testing Technology Co., Ltd.

Address: A101&2FB2, Fuqiao 6th Area, Xintian Community,
Fuhai Street, Baoan District, Shenzhen, China

Telephone: +86-400-8868-419

Fax: +86-755-27790922

Date of Test: Dec. 25, 2023 to Jan. 17, 2024

Date of Report: Jan. 17, 2024

Report Number: NCT240031435XE2-1

TABLE OF CONTENTS

1. TEST RESULT CERTIFICATION	3
2. EUT DESCRIPTION	4
3. SUMMARY OF TEST RESULT	5
4. TEST METHODOLOGY	6
4.1 GENERAL DESCRIPTION OF APPLIED STANDARDS	6
4.2 MEASUREMENT EQUIPMENT USED	6
4.3 DESCRIPTION OF TEST MODES	7
4.4 OPERATIONAL MODES WITHIN A WPT SYSTEM	7
5. FACILITIES AND ACCREDITATIONS	8
5.1 FACILITIES	8
5.2 EQUIPMENT	8
6. TEST SYSTEM UNCERTAINTY	9
7. SETUP OF EQUIPMENT UNDER TEST	10
7.1 SETUP CONFIGURATION OF EUT	10
7.2 SUPPORT EQUIPMENT	12
8. TRANSMITTERS CONFORMANCE REQUIREMENTS	13
8.1 OPERATING FREQUENCY RANGE & Permitted range of operating frequencies	13
8.2 H-FIELD REQUIREMENTS	15
8.3 TRANSMITTER SPURIOUS EMISSIONS	17
8.4 TRANSMITTER OUT OF BAND (OOB) EMISSIONS	21
9. RECEIVERS CONFORMANCE REQUIREMENTS	23
9.1 RECEIVER BLOCKING	23
10. APPENDIX PHOTOGRAPHS OF TEST SETUP	25

1. TEST RESULT CERTIFICATION

Applicant : 2Service B.V.
Address : Santkamp 5, 6836 BE, Arnhem, The Netherlands
Manufacturer : 2Service B.V.
Address : Santkamp 5, 6836 BE, Arnhem, The Netherlands
Product name : Samsung Galaxy watch Charger Mobileparts
Model name : MS-30016

The above-mentioned device is tested by NCT to determine the maximum emission level produced by the device and the severity level that the device can withstand and its performance standards. The measurement results are contained in this test report. In addition, this report shows that EUT (equipment under test) technically meets the requirements of EN303 417

This report only applies to the above-mentioned test samples, and cannot be partially copied or modified without written approval by NCT

Date of Test
Date (s) of performance of tests : Dec. 25, 2023 to Jan. 17, 2024
Date of Issue: Jan. 17, 2024
Test Result: Pass

Test Engineer:

Keven Wu

Keven Wu

Technical Manager:

Henry Wang

Henry Wang



2. EUT DESCRIPTION

Product:	Samsung Galaxy watch Charger Mobileparts
Model Number:	MS-30016
Different:	N/A
Rating:	Type-c Input: 5Vdc,1A Wireless Output :5W
Frequency Range:	145.6KHz
Modulation Technique:	Induction
Antenna Type:	Induction Coil antenna
Antenna Gain:	0 dBm
Temperature Range:	-20°C ~ +55°C

Note: for more details, please refer to the User's manual of the EUT.

3. SUMMARY OF TEST RESULT

Transmitters conformance requirements			
Clause (EN 303 417)	Test Parameter	Verdict	Remark
4.3.2	Permitted Range of Operating Frequencies	PASS	
4.3.3	Operating Frequency Ranges	PASS	
4.3.4	H-Field Requirements	PASS	
4.3.5	Transmitter Spurious Emissions	PASS	
4.3.6	Transmitter Out of Band (OOB) Emissions	PASS	
4.3.7	WPT System Unwanted Conducted Emissions	N/A	Note1
Receivers conformance requirements			
Clause (EN 303 417)	Test Parameter	Verdict	Remark
4.4.2	Receiver Blocking	PASS	Note2
NOTE1:	Only for equipment which has a cable between the off board power supply and the primary coil which is longer than 3 m.		
NOTE2:	Only for Mode 1, Mode 2 and Mode 3		



4. TEST METHODOLOGY

4.1 GENERAL DESCRIPTION OF APPLIED STANDARDS

According to its specifications, the EUT must comply with the requirements of the following standards:
ETSI EN 303 417 –Wireless power transmission systems, using technologies other than radio frequency beam, in the 19 - 21 kHz, 59 - 61 kHz, 79 - 90 kHz, 100 - 300 kHz, 6 765 - 6 795 kHz ranges; Harmonised Standard covering the essential requirements of article 3.2 of Directive 2014/53/EU

4.2 MEASUREMENT EQUIPMENT USED

Name	Model No.	Serial No.	Manufacturer	Last calibration	Calibrated until
Radiated emission					
EMI Test Receiver	ESCI	101178	RS	2023/6/20	2024/6/21
Spectrum Analyzer	N9020A	MY5051 0202	Agilent	2023/6/20	2024/6/21
Amplifier	BBV 9743 B	00374	SCHWARZBECK	2023/6/20	2024/6/21
Bilog Antenna	VULB9162	00473	SCHWARZBECK	2023/6/20	2024/6/21
Horn antenna	BBHA 9120 D	02622	SCHWARZBECK	2023/6/20	2024/6/21
Preamplifier	BBV 9718D	00042	SCHWARZBECK	2023/6/20	2024/6/21

4.3 DESCRIPTION OF TEST MODES

The EUT has been tested under its typical operating condition.

The EUT configuration for testing is installed on RF field strength measurement to meet the Commissions requirement and operating in a manner which intends to maximize its emission characteristics in a continuous normal application.

The Transmitter was operated in the normal operating mode. The TX frequency was fixed which was for the purpose of the measurements.

Test of channel included the lowest and middle and highest frequency to perform the test, then record on this report.

The EUT has been tested under its typical operating condition. so those modulation and channel were used for all test.

Pre-defined engineering program for regulatory testing used to control the EUT for staying in continuous transmitting and receiving mode is programmed.

4.4 OPERATIONAL MODES WITHIN A WPT SYSTEM

	Operational Mode	Set-up	Function of base station	Function of mobile device	Test scenario
<input checked="" type="checkbox"/>	Mode 1: base station in stand-by, idle mode	Single device	Transmitter	Not applicable	Single radiation test (TX) with the base station/charging pad. The test set-up as described in clause 6.1.2 shall be used.
<input checked="" type="checkbox"/>	Mode 2: Communication before charging, adjustment charging mode / position	In combination	TX and RX	TX and RX	Specific test setup, declared by the manufacturer. Manufacturer shall declare the maximal distance between base station and mobile device the WPT system is able to communicate (distance D). The test setup- up shall be performed with the largest communication distance. The test set-up as described in clause 6.1.3 shall be used.
<input checked="" type="checkbox"/>	Mode 3: Communication	WPT system alignment	TX and RX	TX and RX	Worst case alignment Both tests can be performed within one set-up, worst-case alignment. The test set-up as described in clause 6.1.4 shall be used.
<input type="checkbox"/>	Mode 4: energy transmission	WPT system alignment	TX and RX	TX and RX	

5. FACILITIES AND ACCREDITATIONS

5.1 FACILITIES

Name of Test Firm	Shenzhen NCT Testing Technology Co., Ltd.
Site Location	A101&2FB2, Fuqiao 6th Area, Xintian Community, Fuhai Street, Baoan District, Shenzhen, China

5.2 EQUIPMENT

Radiated emissions are measured with one or more of the following types of linearly polarized antennas: tuned dipole, biconical, log periodic, bi-log, and/or ridged waveguide, horn. Spectrum analyzers with preselectors and quasi-peak detectors are used to perform radiated measurements.

Conducted emissions are measured with Line Impedance Stabilization Networks and EMI Test Receivers.

Calibrated wideband preamplifiers, coaxial cables, and coaxial attenuators are also used for making measurements.

All receiving equipment conforms to CISPR Publication 16-1, "Radio Interference Measuring Apparatus and Measurement Methods."

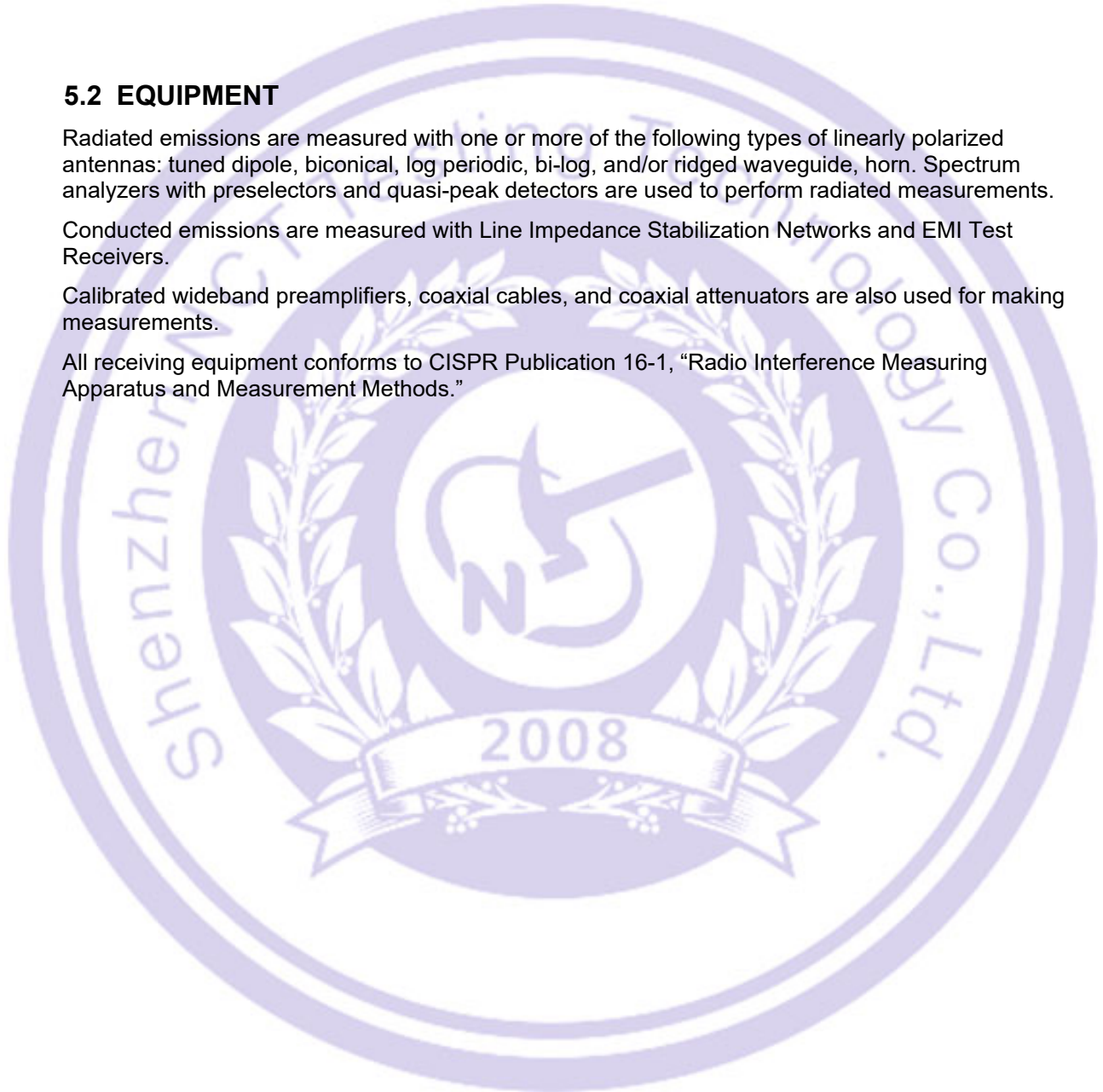

6. TEST SYSTEM UNCERTAINTY

Maximum measurement uncertainty of the test system

Test Parameter	Measurement Uncertainty
Radio frequency	± 0.1 ppm
RF power, conducted	± 1 dB
RF power, radiated	± 6 dB
Temperature	± 1 °C
Humidity	± 5 %



7. SETUP OF EQUIPMENT UNDER TEST

7.1 SETUP CONFIGURATION OF EUT

Conducted measurements configuration of EUT shall be as follows:

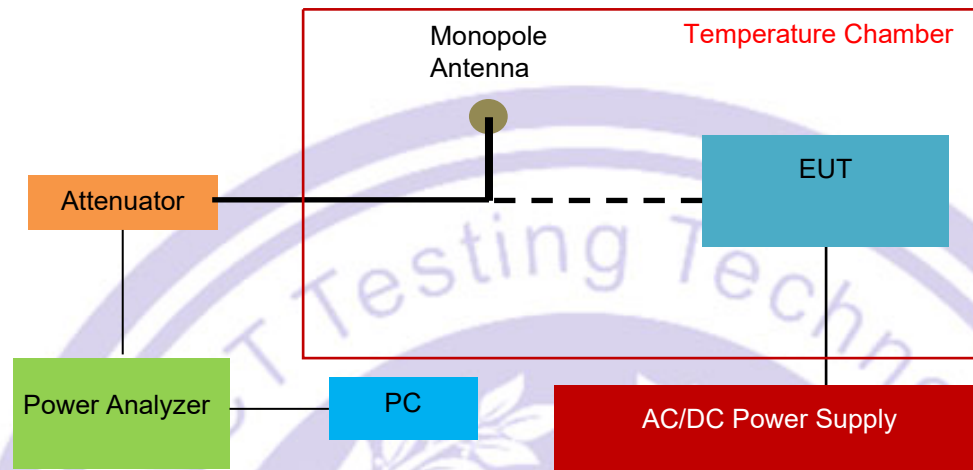

Remarks:

The Signal Analyzer could be connected to a monopole antenna or directly connected to the EUT, if the EUT has already employing an antenna connector.

Radiated measurements configuration of EUT shall be as follows:

Below 30MHz

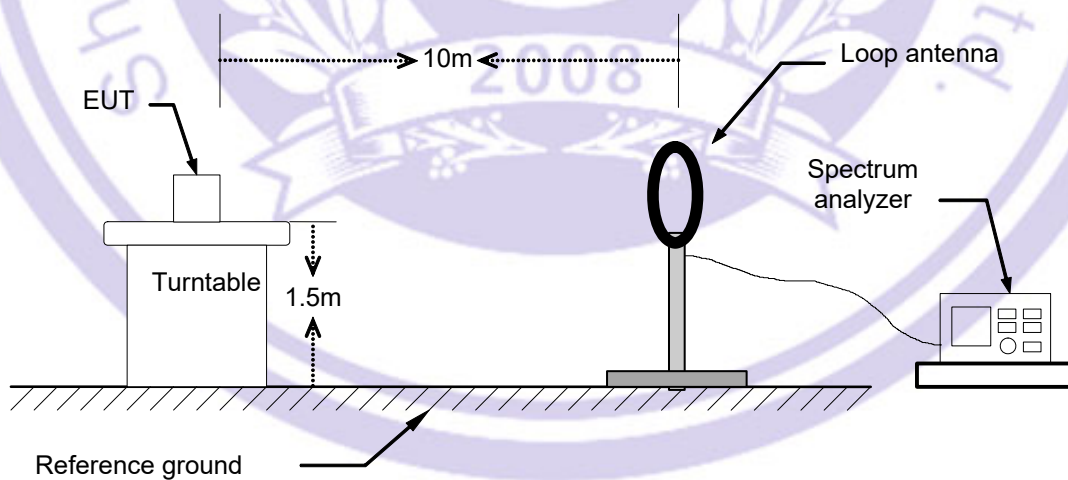

Below 1GHz

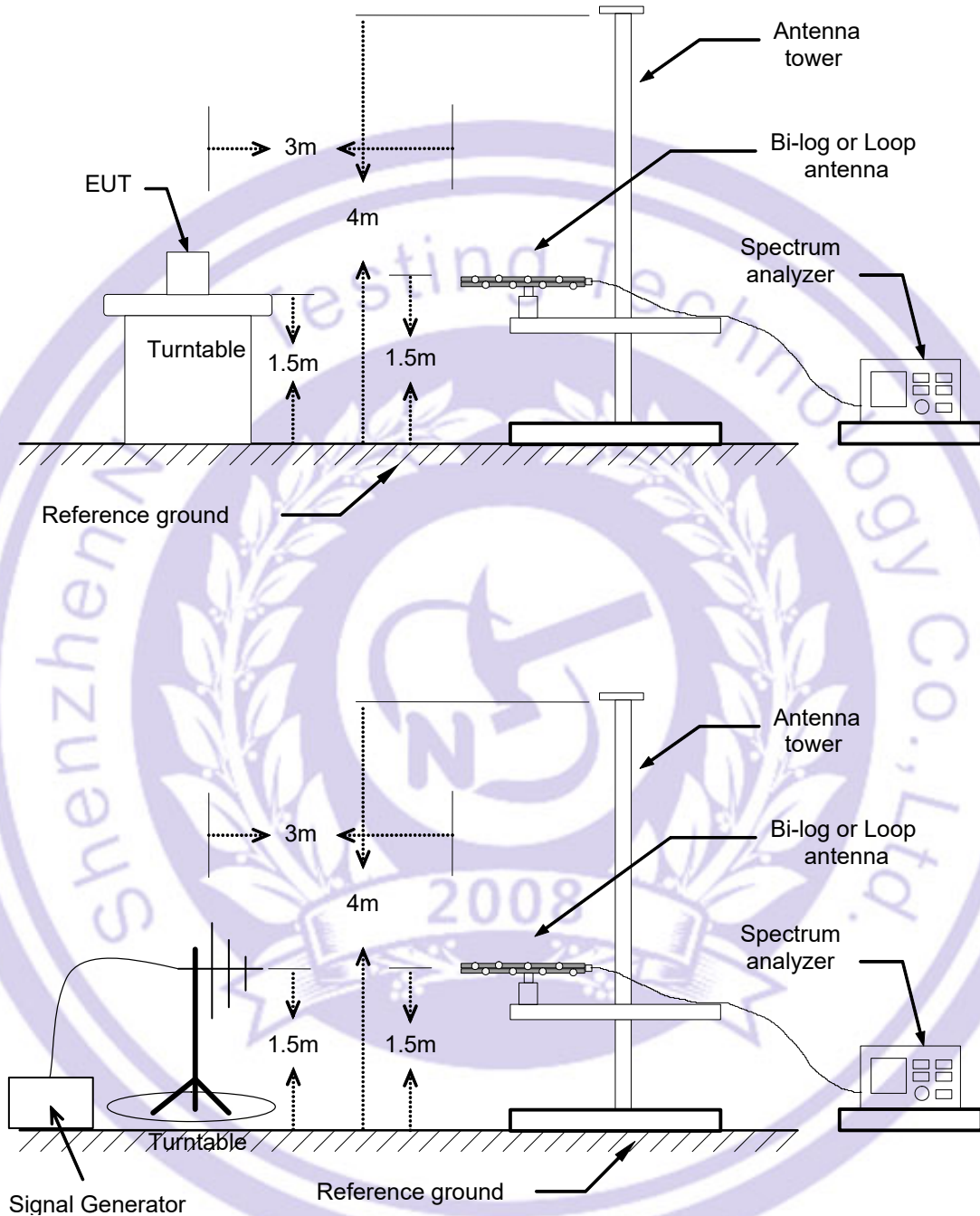

Above 1GHz

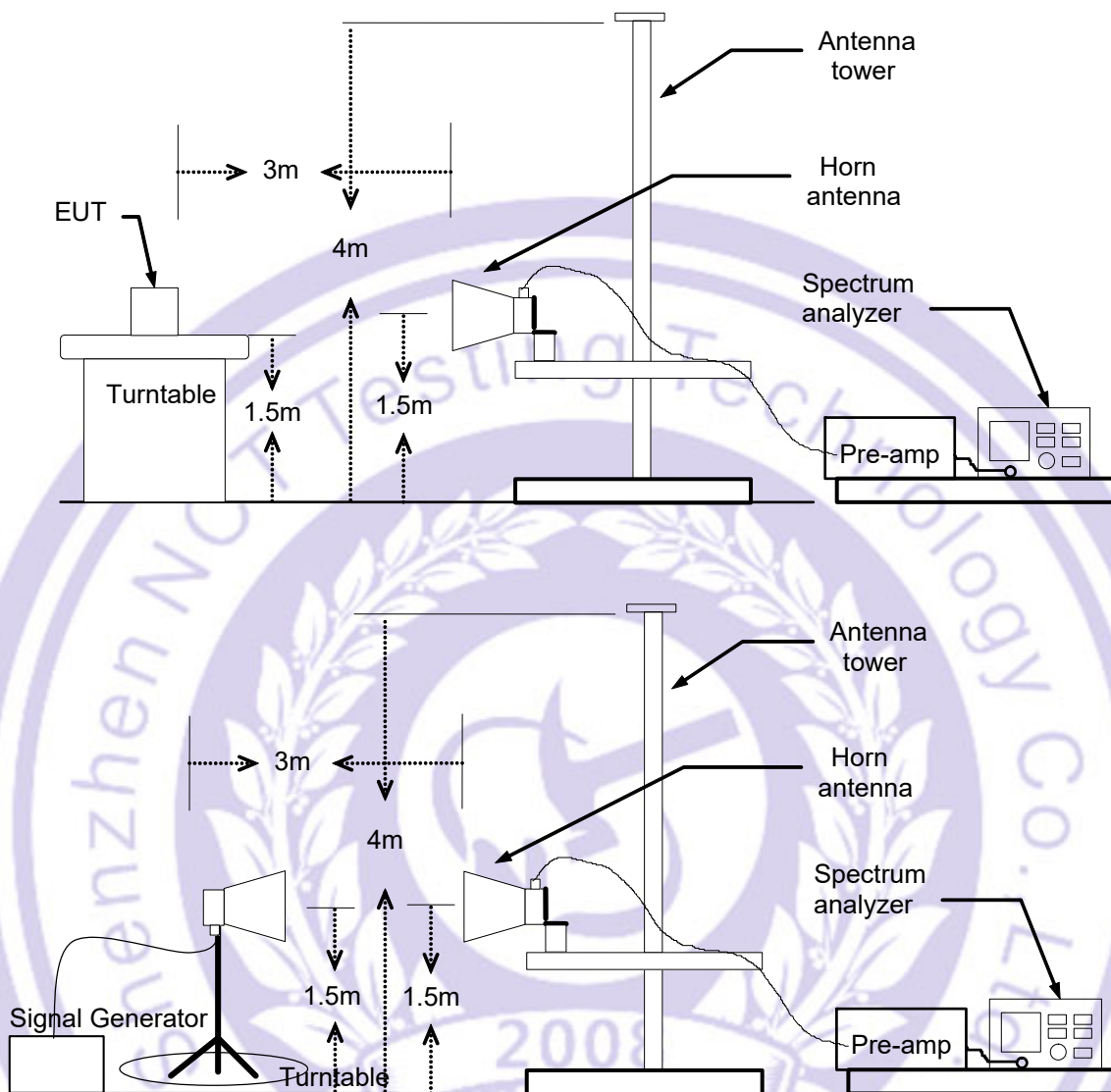

7.2 SUPPORT EQUIPMENT

Item	Equipment	Mfr/Brand	Model/Type No.	Series No.	Note
1.	Load	N/A	N/A	N/A	Fully-shielded

Notes:

1. All the equipment/cables were placed in the worst-case configuration to maximize the emission during the test.
2. Grounding was established in accordance with the manufacturer's requirements and conditions for the intended use.

8. TRANSMITTERS CONFORMANCE REQUIREMENTS

8.1 OPERATING FREQUENCY RANGE & Permitted range of operating frequencies

8.1.1 Applicable standard

EN 303 417 Clause 4.3.2 and 4.3.3

8.1.2 Conformance Limit

The permitted range of operating frequency range(s) for intentional emissions shall be within 19 - 21 kHz, 59 - 61 kHz, 79 - 90 kHz, 100 - 300 kHz, 6 765 - 6 795 kHz.

For a single frequency systems the OFR is equal to the occupied bandwidth (OBW) of the WPT system.

For multi-frequency systems the OFR is described as below.

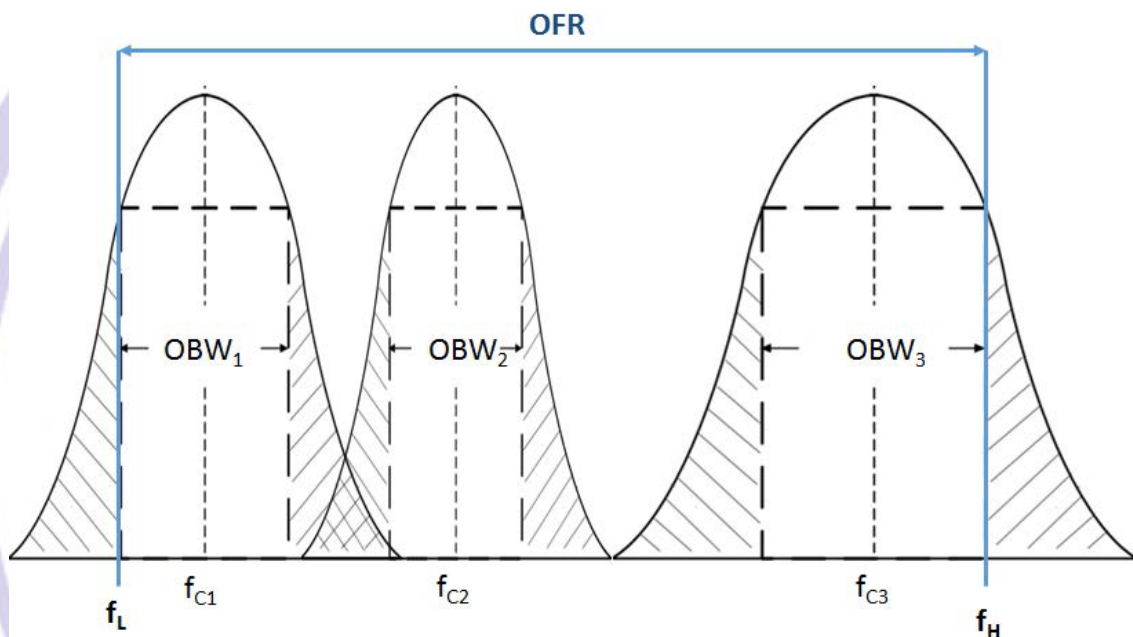

OFR of a multi - frequency WPT system within one frequency range and within one WPT system cycle time

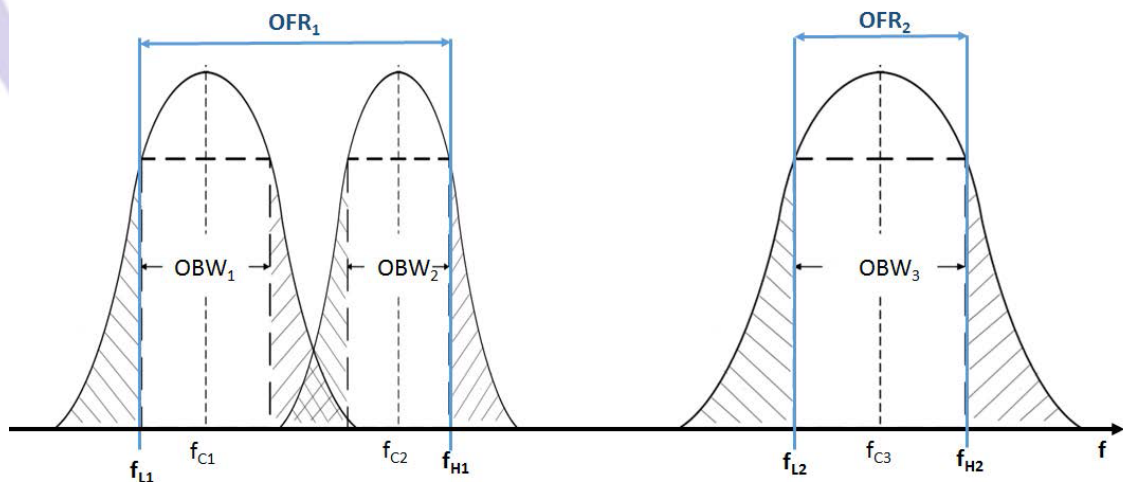

OFR of a multi - frequency WPT system within two frequency ranges and within one WPT system cycle time

8.1.3 Test Configuration

The measurements shall be performed at both normal environmental conditions and at the extremes of the operating temperature range.

Radiated measurements shall only be used for integral antenna equipment that does not have a temporary antenna connector(s) provided.

Conducted measurements shall be used for antenna equipment provided a temporary antenna connector(s).

8.1.4 TEST PROCEDURE

1. Please refer to ETSI EN 303 417 (V1.1.1) clause 5 for the test conditions.
2. Please refer to ETSI EN 303 417 (V1.1.1) clause 6.2.1 for the measurement method.

The test procedure shall be as follows:

■ OFR measurement with spectrum analyser

The measurement antenna shall be placed at one point of the setup up. Alternatively, a current probe could be used.

A spectrum analyser with the following settings is used as measuring receiver in the test set-up:

- Start frequency: lower than the lower edge of the permitted frequency range.
- Stop frequency: higher than the upper edge of the permitted frequency range.
- Resolution Bandwidth: 10KHz.
- Video Bandwidth: \geq Resolution Bandwidth.
- Detector mode: RMS.
- Display mode: Maxhold.

The 99 % OBW function shall be used to determine the operating frequency range:

- f_H is determined. f_H is the frequency of the upper marker resulting from the OFR.
- f_L is determined. f_L is the frequency of the lower marker resulting from the OFR.
- f_c is the centre frequency. $f_c = (f_H + f_L)/2$

8.1.5 Test Results

Test Conditions		Operating Frequency Ranges		
Temp.	Voltage	f_L (KHz)	f_H (KHz)	f_c (KHz)
25 °C	V_{nor}	145.6905	145.7958	145.8011
-20°C	V_{min}	145.7912	145.7966	145.8019
	V_{max}	145.7916	145.7970	145.8023
55°C	V_{min}	145.7919	145.7973	145.8027
	V_{max}	145.7918	145.7971	145.8024
Limit		100 KHz < f < 300 KHz		

8.2H-FIELD REQUIREMENTS

8.2.1 Applicable standard

ETSI EN 303 417 clause 4.3.4

8.2.2 Conformance Limit

The H-field limits are provided in below.

They have been specified for control of any radiated emissions within the OFR originating from the WPT system (power transmission and accompanying data communication).

The H-field limits in below are EU wide harmonised according to EC Decision 2013/752/EU [i.2].

Further information is available in ERC/REC 70-03 [i.1].

Frequency range [MHz]	H-field strength limit [dB μ A/m at 10 m]	Comments
$0,019 \leq f < 0,021$	72	
$0,059 \leq f < 0,061$	69,1 descending 10 dB/dec above 0,059 MHz	See note 1
$0,079 \leq f < 0,090$	67,8 descending 10 dB/dec above 0,079 MHz	See note 2
$0,100 \leq f < 0,119$	42	
$0,119 \leq f < 0,135$	66 descending 10 dB/dec above 0,119 MHz	See note 1
$0,135 \leq f < 0,140$	42	
$0,140 \leq f < 0,1485$	37,7	
$0,1485 \leq f < 0,30$	-5	
$6,765 \leq f < 6,795$	42	

NOTE 1: Limit is 42 dB μ A/m for the following spot frequencies: 60 kHz \pm 250 Hz and 129,1 kHz \pm 500 Hz.

NOTE 2: At the time of preparation of the present document the feasibility of increased limits for high power wireless power transmission systems to charge vehicles [i.4] was prepared. New specific requirements for such systems (e.g. higher H-field emission limits in the 79 - 90 kHz band) will be reflected within a future revision of the present document.

8.2.3 Test Configuration

The measurements shall be performed at normal environmental conditions of the operating temperature range.

Radiated measurements shall only be used for integral antenna equipment that does not have a temporary antenna connector(s) provided.

8.2.4 Test Procedure

1. Please refer to ETSI EN 303 417 (V1.1.1) clause 5 for the test conditions.
2. Please refer to ETSI EN 303 417 (V1.1.1) clause 6.2.1 for the measurement method.

The test procedure shall be as follows:

The test procedure shall be as follows:

The measurements of the transmitter radiated H-field shall be made on an open field test site. Any measured values shall be at least 6 dB above the ambient noise level.

The H-field produced by the equipment shall be measured at standard distance of 10 m. Where this is not practical, e.g. due to physical size of the equipment including the antenna or with use of special field cancelling antenna, then other distances may be used. When another distance is used, the distance used and the field strength value measured shall be stated in the test report. In this case, the measured value at actual test distance shall be extrapolated to 10 m according to annex H and these calculations shall be stated in the test report.

The H-field is measured with a shielded loop antenna connected to a measurement receiver. The measuring bandwidth and detector type of the measurement receiver shall be Meet the requirements.

The equipment under test shall operate where possible, with modulation. Where this is not possible, it shall be stated in the test report.

For transmitters using a continuous wideband swept carrier, the measurement shall be made with the sweep off. When it is not possible to turn the sweep off the measurements shall be made with the sweep on and this shall be stated in the test report.

For measuring equipment calibrated in dB μ V/m, the reading should be reduced by 51,5 dB to be converted to dB μ A/m.

8.2.5 Test Results

Frequency (KHz)	Antenna Polarization	Test data (dBuA/m)	Limit (dBuA/m)	Result
145.69	X	3.18	42.00	Pass
145.69	Y	-3.51	42.00	Pass
145.69	Z	1.26	42.00	Pass

8.3 TRANSMITTER SPURIOUS EMISSIONS

8.3.1 Applicable standard

ETSI EN 303 417 clause 4.3.5

8.3.2 Conformance Limit

Below 30MHz

The radiated field strength of the spurious domain emissions below 30 MHz shall not exceed the generated H-field dBuA/m at 10 m given in below.

State	Frequency 9kHz≤f<10MHz	Frequency 10MHz≤f<30MHz
Operating	27dBuA/m at 9kHz descending 10dB/dec	-3.5dBuA/m
Standby	5.5dBuA/m at 9kHz descending 10dB/dec	-25dBuA/m
NOTE: "Operating" means mode 2, 3 and 4; "standby" means mode 1		

Above 30MHz

The power of any radiated spurious emission between 30 MHz and 1 GHz shall not exceed the values given in below.

State	47MHz to 74MHz 87.5MHz to 118MHz 174MHz to 230MHz 470MHz to 790MHz	Other frequencies between 30MHz to 1000MHz
Operating	4nW(-54dBm)	250nW(-36dBm)
Standby	2nW(-57dBm)	2nW(-57dBm)

8.3.3 Test Configuration

The measurements shall be performed at normal environmental conditions of the operating temperature range.

Radiated measurements shall only be used for integral antenna equipment that does not have a temporary antenna connector(s) provided.

8.3.4 Test Procedure

1. Please refer to ETSI EN 303 417 (V1.1.1) clause 5 for the test conditions.
2. Please refer to ETSI EN 303 417 (V1.1.1) clause 6.2.1 for the measurement method.

The test procedure shall be as follows:

Below 30MHz

The field strength shall be measured for frequencies below 30 MHz. The equipment under test shall be measured at a distance of 10 m on an outdoor test site. The test antenna shall be a calibrated shielded magnetic field antenna. The equipment under test and test antenna shall be arranged as stated.

The equipment under test shall be switched on with normal modulation. The characteristics of the modulation signal used shall be stated on the test report. The measuring receiver shall be tuned over the frequency range 9 kHz to 30 MHz, except for the frequency band on which the transmitter is intended to operate.

At each frequency at which a relevant spurious signal is detected the equipment under test and the test antenna shall be rotated until maximum field strength is indicated on the measuring receiver. This level shall be noted.

If the transmitter can be operated in the standby mode, then the measurements shall be repeated in the standby mode.

For measuring equipment calibrated in dB μ V/m, the reading should be reduced by 51,5 dB to be converted to dB μ A/m.

Above 30MHz

The equipment shall be placed at the specified height on a non-conducting support and in the position closest to normal use as declared by the manufacturer.

The test antenna shall be oriented for vertical polarization. The output of the test antenna shall be connected to a measuring receiver.

The transmitter shall be switched on with normal modulation, and the measuring receiver shall be tuned over the frequency range 30 MHz to 1 000 MHz.

At each frequency at which a relevant spurious component is detected, the test antenna shall be raised and lowered through the specified range of heights until a maximum signal level is detected on the measuring receiver.

The transmitter shall then be rotated through 360° in the horizontal plane, until the maximum signal level is detected by the measuring receiver.

The maximum signal level detected by the measuring receiver shall be noted.

The substitution antenna shall be oriented for vertical polarization and calibrated for the frequency of the spurious component detected.

The frequency of the calibrated signal generator shall be set to the frequency of the spurious component detected. The input attenuator setting of the measuring receiver shall be adjusted in order to increase the sensitivity of the measuring receiver, if necessary.

The test antenna shall be raised and lowered through the specified range of heights to ensure that the maximum signal is received.

When a test site is used, there is no need to vary the height of the antenna.

The input signal to the substitution antenna shall be adjusted until an equal or a known related level to that detected from the transmitter is obtained on the measuring receiver.

The input signal to the substitution antenna shall be recorded as a power level and corrected for any change of input attenuator setting of the measuring receiver.

The measure of the effective radiated power of the spurious components is the larger of the two power levels recorded for each spurious component at the input to the substitution antenna, corrected for the gain of the substitution antenna if necessary.

If an unmodulated carrier cannot be obtained then the measurements shall be made with the transmitter modulated by the normal test signal in which case this fact shall be recorded in the test report.

If standby mode is available, the measurements shall be repeated in that mode.

8.3.5 Test Results

All mode and extreme test conditions have been tested, and worst result(Mode 3&Mode 1) have been recorded in the follow table.

■ Transmitter Spurious Emissions below 30MHz

Freq. (MHz)	Ant.Pol.	Emission Level (dBuA/m)	Limit 10m (dBuA/m)	Over (dB)	Result
0.061	X	11.75	20.58	-8.83	Pass
0.153	X	-5.87	16.22	-22.09	Pass
0.298	X	-9.7	14.43	-24.13	Pass
0.117	Y	4.04	16.67	-12.63	Pass
0.195	Y	-6.03	15.70	-21.73	Pass
0.341	Y	5.78	13.90	-8.12	Pass
0.154	Z	8.65	16.20	-7.55	Pass
0.237	Z	-6.52	15.18	-21.70	Pass
0.380	Z	-7.79	13.42	-21.21	Pass

Note: (1)Emission Level= Reading Level+Probe Factor +Cable Loss.

■ Transmitter Spurious Emissions below 30MHz

Temperature:	24°C		
Humidity:	53 % RH	Tested by:	LYF
Mode:	Mode 1-standby		

Freq. (MHz)	Ant.Pol.	Emission Level (dBuA/m)	Limit 10m (dBuA/m)	Over (dB)	Result
0.045	X	-11.32	1.05	-12.37	Pass
0.095	X	-11.48	-1.91	-9.57	Pass
19.720	X	-37.25	-25.00	-12.25	Pass
0.121	Y	-9.58	-4.88	-4.70	Pass
0.253	Y	-24.17	-6.51	-17.66	Pass
14.988	Y	-36.82	-25.00	-11.82	Pass
0.208	Z	-10.04	-5.96	-4.08	Pass
0.321	Z	-24.1	-7.35	-16.75	Pass
17.526	Z	-36.18	-25.00	-11.18	Pass

Note: (1)Emission Level= Reading Level+Probe Factor +Cable Loss.

■ Transmitter Spurious Emissions above 30MHz

Frequency (MHz)	Antenna Polarization		Emission level (dBm)	Limit (dBm)	Over Limit (dBm)	Verdict
38.425	<input checked="" type="checkbox"/> V <input type="checkbox"/> H	<input type="checkbox"/> conducted	-70.37	-36.00	-34.37	PASS
51.410			-69.81	-36.00	-33.81	PASS
222.464			-67.76	-54.00	-13.76	PASS
305.357			-57.72	-36.00	-21.72	PASS
460.546			-68.11	-36.00	-32.11	PASS
730.566			-70.29	-54.00	-16.29	PASS

Frequency (MHz)	Antenna Polarization		Emission level (dBm)	Limit (dBm)	Over Limit (dBm)	Verdict
37.970	<input type="checkbox"/> V <input checked="" type="checkbox"/> H	<input type="checkbox"/> conducted	-60.29	-36.00	-24.29	PASS
54.710			-62.06	-54.00	-8.06	PASS
57.604			-60.70	-54.00	-6.70	PASS
58.421			-60.56	-54.00	-6.56	PASS
188.879			-64.41	-54.00	-10.41	PASS
214.050			-63.90	-54.00	-9.90	PASS

Temperature: 24°C
 Humidity: 53 % RH
 Mode: Mode 1-standby
 Tested by: LYF

Frequency (MHz)	Antenna Polarization		Emission level (dBm)	Limit (dBm)	Over Limit (dBm)	Verdict
37.794	<input checked="" type="checkbox"/> V <input type="checkbox"/> H	<input type="checkbox"/> conducted	-64.70	-57.00	-7.70	PASS
38.394			-62.50	-57.00	-5.50	PASS
191.951			-64.94	-57.00	-7.94	PASS
200.808			-64.67	-57.00	-7.67	PASS
212.000			-63.84	-57.00	-6.84	PASS
308.472			-65.37	-57.00	-8.37	PASS

Frequency (MHz)	Antenna Polarization		Emission level (dBm)	Limit (dBm)	Over Limit (dBm)	Verdict
210.575	<input type="checkbox"/> V <input checked="" type="checkbox"/> H	<input type="checkbox"/> conducted	-68.96	-57.00	-11.96	PASS
223.824			-70.03	-57.00	-13.03	PASS
293.478			-63.85	-57.00	-6.85	PASS
311.181			-63.02	-57.00	-6.02	PASS
454.882			-71.28	-57.00	-14.28	PASS
985.880			-66.8	-57.00	-9.8	PASS

8.4 TRANSMITTER OUT OF BAND (OOB) EMISSIONS

8.4.1 Applicable standard

ETSI EN 303 417 clause 4.3.6

8.4.2 Conformance Limit

The transmitter spurious emissions for a single frequency system are to be considered in frequency ranges defined in below ($f < f_{SL}$ and $f > f_{SH}$).

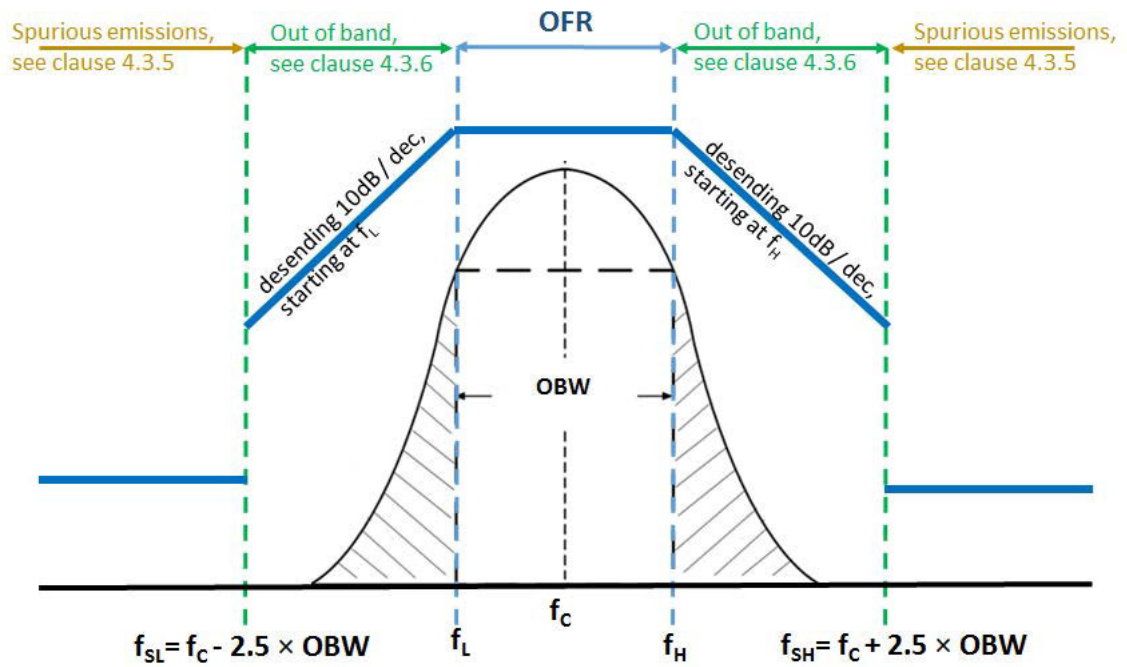

The transmitter spurious emissions for a multi frequency system are to be considered in frequency ranges defined in below ($f < f_{SL}$ and $f > f_{SH}$).

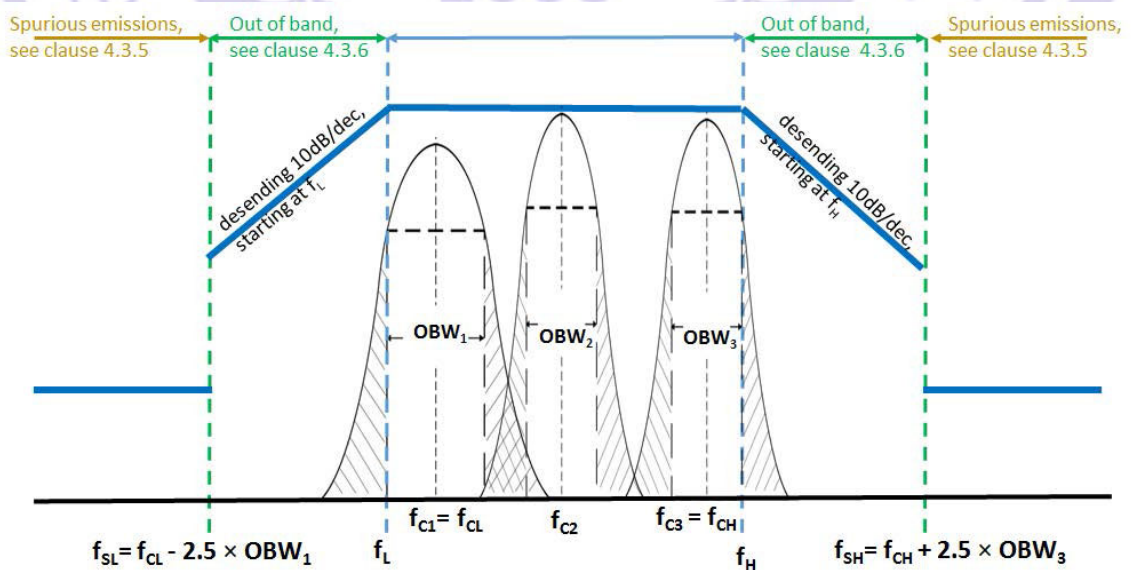

8.4.3 Test Configuration

The measurements shall be performed at normal environmental conditions of the operating temperature range.

Radiated measurements shall only be used for integral antenna equipment that does not have a temporary antenna connector(s) provided.

8.4.4 Test Procedure

1. Please refer to ETSI EN 303 417 (V1.1.1) clause 5 for the test conditions.
2. Please refer to ETSI EN 303 417 (V1.1.1) clause 6.2.1 for the measurement method.

The test procedure shall be as follows:

The field strength shall be measured for frequencies below 30 MHz. The equipment under test shall be measured at a distance of 10 m on an outdoor test site. The test antenna shall be a calibrated shielded magnetic field antenna. The equipment under test and test antenna shall be arranged as stated.

The equipment under test shall be switched on with normal modulation. The characteristics of the modulation signal used shall be stated on the test report. The measuring receiver shall be tuned over the frequency range 9 kHz to 30 MHz, except for the frequency band on which the transmitter is intended to operate.

At each frequency at which a relevant spurious signal is detected the equipment under test and the test antenna shall be rotated until maximum field strength is indicated on the measuring receiver. This level shall be noted.

If the transmitter can be operated in the standby mode, then the measurements shall be repeated in the standby mode.

For measuring equipment calibrated in dB μ V/m, the reading should be reduced by 51,5 dB to be converted to dB μ A/m

8.4.5 Test Results

Pass

9. Receivers conformance requirements

9.1 RECEIVER BLOCKING

9.1.1 Applicable standard

ETSI EN 303 417 clause 4.4.2

9.1.2 Conformance Limit

	In-band signal	OOB signal	Remote-band signal
Frequency	Centre frequency (f_c) of the WPT system	$f = f_c \pm F$ (see note)	$f = f_c \pm 10 \times F$ (see note)
Signal level field strength at the EUT	72 dB μ A/m	72 dB μ A/m	82 dB μ A/m
NOTE: $F = OFR$			

9.1.3 Test Configuration

The measurement is performed at an operating frequency declared by the manufacturer. An EUT without a permanent or temporary antenna connector shall be tested according to Radiated measurement

An EUT with a permanent or temporary antenna connector shall be tested according to Conducted measurement

9.1.4 Test Procedure

1. Please refer to ETSI EN 303 417 clause 5 for the test conditions.
2. Please refer to ETSI EN 303 417 clause 6.3.2 for the measurement method.

The test procedure shall be as follows:

The fulfilment of the WPT system performance criterion in all possible operational modes (see clause 4.2.3) shall be tested in presence of the inference signals according to Table 6.

- The manufacturer shall declare in which device orientation(s) (worst case) the test shall be performed.
- The WPT system shall initially operate without interference according to its specified sensitivity (detecting an specific object in the maximum depth as declared by the manufacturer (see clause 4.2.2 on wanted performance criteria)).
- The test setup is visualized in the following Figures 11 and 12.
- The tool shall be operated as intended (e.g. some tools might require to be moved across the object, some tool can be used stationary).
- The test shall be carried out inside a test chamber according to clauses C.1.1 and C.1.2 in ETSI EN 300 330 [1].
- A test loop with a radius r shall be used to create the magnetic field; the test loop shall lie on a non-metallic ground and the minimum distance to metallic objects (e.g. ground plane) shall be 0,75 m.
- The EUT shall be placed to the centre of the test-loop (e.g. see Figures 11 and 12).
- The test loop shall be sufficiently large so that the test loop itself does not influence the WPT system; The radius R of the test-loop shall be in minimum $\Delta R = 0,75$ m larger than the maximum dimension r of the EUT.
- (See Figure 12): $R \geq r + \Delta R$.
- The maximum H-Field can be calculated from the loop current I (into the test-loop) with the following formula: $H=I/2R$
- The required output current to achieve the required magnetic field from Table 12 at the WPT system shall be generated with a signal generator (unmodulated signal) at the test frequencies

from Table 6.

- For each test frequency the "reaction" of the device shall be recorded and checked against the performance criterion from clause 4.2.2.

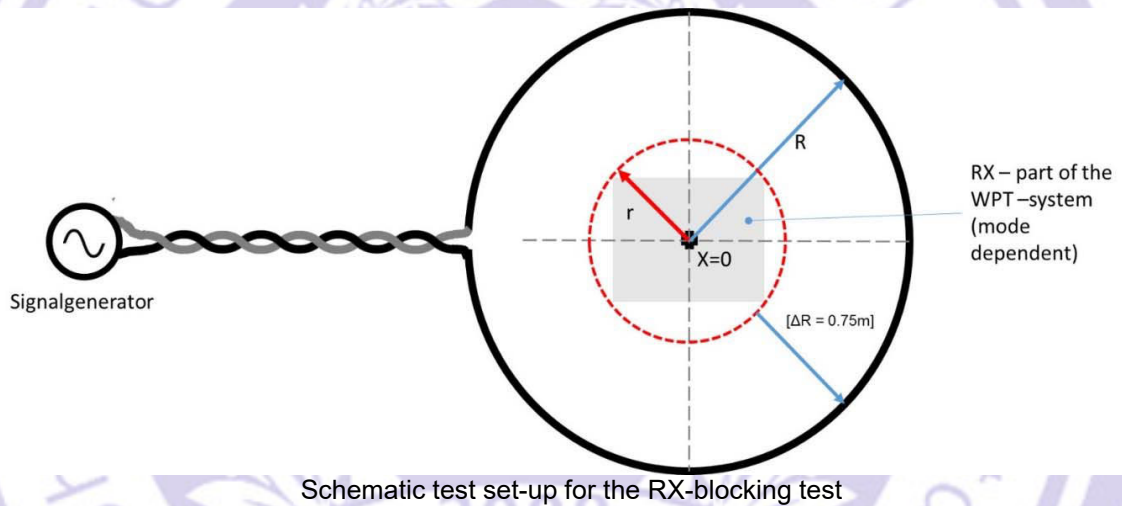
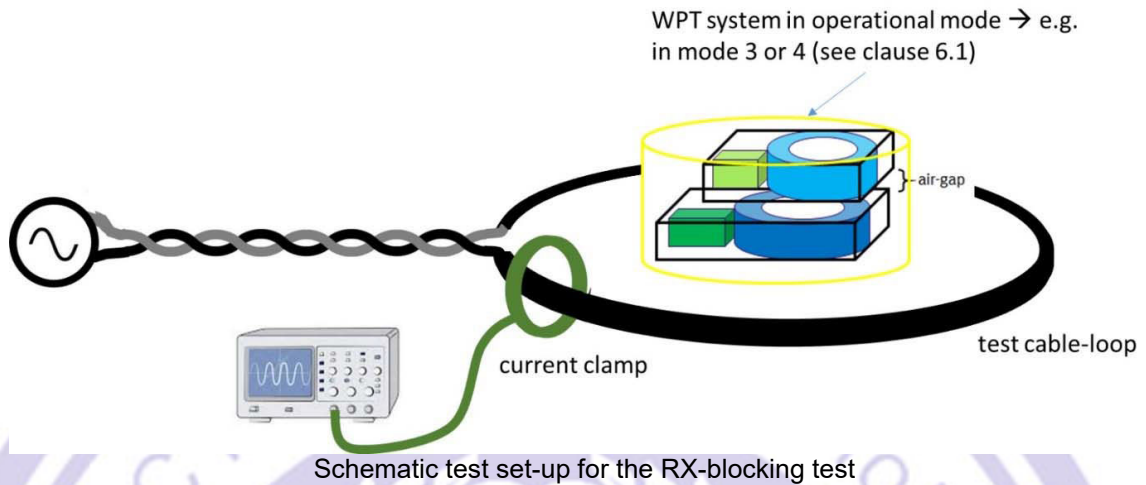

If the WPT system meets the wanted performance criterion at all times, then the test shall be considered as passed.
 Otherwise, the test is considered as failed.

9.1.5 Test Results

All mode and extreme test conditions have been tested, and worst result(Mode 3) have been recorded in the follow table.

	Frequency	Signal level field strength at the EUT	Result
In-band signal	f_c	72 dB μ A/m	The EUT use as intended without degradation of performance
OOB signal	$f = f_c \pm F$	72 dB μ A/m	
Remote-band signal	$f = f_c \pm 10 \times F$	82 dB μ A/m	
Note 1: F = OFR			

10. APPENDIX PHOTOGRAPHS OF TEST SETUP

