

TECHNICAL REPORT



Report No.: TW2201060E  
File Reference No.: 2022-01-18  
Applicant: 2Service B.V.  
Product: Promiz ANC TWS Earbuds  
Trademark: promiz  
Model No.: PZ-60003, SS-TS139N  
Test Standards: EN 55032:2015+A11:2020+A1:2020  
EN IEC 61000-3-2:2019+A1:2021  
EN 55035:2017+A11:2020  
EN 61000-3-3: 2013+A1:2019  
Test Result: The EMC testing has been performed on the submitted samples and found in compliance with council EMC Directive 2014/30/EU.

Approved By

Handwritten signature of Terry Tang in black ink.

Terry Tang

Manager

Dated: January 18, 2022

**Results appearing herein relate only to the sample tested**  
**The technical reports is issued errors and omissions exempt and is subject to withdrawal at**

**SHENZHEN TIMEWAY TESTING LABORATORIES**

Zone C, 1st Floor, Block B, Jun Xiang Da Building, Zhongshan Park Road West, Tong Le Village, Nanshan District, Shenzhen, China  
Tel (755) 83448688, Fax (755) 83442996, E-Mail:info@timeway-lab.com



### **Special Statement:**

The testing quality ability of our laboratory meet with "Quality Law of People's Republic of China" Clause 19.

The testing quality system of our laboratory meet with ISO/IEC-17025 requirements, which is approved by CNAS. This approval result is accepted by MRA of APLAC.

Our test facility is recognized, certified, or accredited by the following organizations:

#### **CNAS-LAB Code: L2292**

The EMC Laboratory has been assessed and in compliance with CNAS-CL01 accreditation criteria for testing Laboratories (identical to ISO/IEC 17025:2005 General Requirements) for the Competence of testing Laboratories.

#### **FCC-Registration No.: 744189**

The EMC Laboratory has been registered and fully described in a report filed with the (FCC) Federal Communications commission. The acceptance letter from the FCC is maintained in our files. Registration No.: 744189.

#### **Industry Canada (IC) —Registration No.:5205A**

The EMC Laboratory has been registered by Certification and Engineering Bureau of Industry Canada for radio equipment testing with Registration No.: 5205A.

#### **A2LA (Certification Number:5013.01)**

The EMC Laboratory has been accredited by the American Association for Laboratory Accreditation (A2LA). Certification Number:5013.01



TABLE OF CONTENT

Test Report Conclusion  
Special Statement  
Content

<b>1.0</b>	<b><u>General Details</u></b> .....	5
1.1.	Test Lab Details.....	5
1.2	Applicant Details.....	5
1.3	Description of EUT .....	5
1.4	Submitted Sample.....	5
1.5	Test Duration.....	6
1.6	Additional Information of EUT.....	6
1.7	Test Engineer & Verify Engineer.....	6
<b>2.0</b>	<b><u>List of Measurement Equipment</u></b> .....	7
2.1	Conducted Emission Test.....	7
2.2	Radiated Disturbance Test.....	7
2.3	Harmonic& Flicker Test.....	7
2.4	ESD Test .....	7
2.5	RF Field Strength Susceptibility.....	7
2.6	Electrical Fast Transient/Burst (EFT/B) Immunity Test.....	8
2.7	Surge Test.....	8
2.8	Conducted Immunity Test.....	8
2.9	Power-Frequency Magnetic Field.....	8
2.10	Voltage Dips/Interruption Immunity Test.....	9
<b>3.0</b>	<b><u>Technical Details</u></b> .....	10
3.1	Investigations Requested.....	10
3.2	Test Standards.....	10
3.3	Performance Criteria.....	10
3.4	Test Standards and Results Summary Tables.....	11
<b>4.0</b>	<b><u>Electromagnetic Interference Test Results</u></b> .....	12
4.1	Power line Conducted Emission Test.....	12
4.2	Telecommunication Ports Conducted Emission Test.....	15
4.3	Radiated Disturbance Test.....	18
4.4	Harmonic Current Emission Test.....	21
4.5	Voltage Fluctuations & Flicker Test.....	23
<b>5.0</b>	<b><u>Immunity Test</u></b> .....	24

The report refers only to the sample tested and does not apply to the bulk.  
This report is issued in confidence to the client and it will be strictly treated as such by the SHENZHEN TIMEWAY TESTING LABORATORIES. It may not be reproduced rather in its entirety or in part and it may not be used for advertising. The client to whom the report is issued may, however, show or send it . or a certified copy there of prepared by the SHENZHEN TIMEWAY TESTING LABORATORIES. to his customer. Supplier or others persons directly concerned. SHENZHEN TIMEWAY TESTING LABORATORIES. will not, without the consent of the client enter into any discussion of correspondence with any third party concerning the contents of the report.  
In the event of the improper use of the report. The SHENZHEN TIMEWAY TESTING LABORATORIES. reserves the rights to withdraw it and to adopt any other remedies which may be appropriate.



5.1	Electrostatic Discharge.....	24
5.2	RF Field transients / Burst Immunity Test.....	26
5.3	Electrical Fast Transient/Burst (EFT/B) immunity test.....	28
5.4	Surge Test.....	30
5.5	Conducted Immunity Test.....	32
5.6	Power-Frequency Magnetic Field.....	34
5.7	Voltage Dips / Interruptions Immunity Test.....	36
<b>6.0</b>	<b>Product Labeling.....</b>	<b>38</b>
6.1	CE Mark label specification.....	38
	Appendix.....	39

The report refers only to the sample tested and does not apply to the bulk.  
This report is issued in confidence to the client and it will be strictly treated as such by the SHENZHEN TIMEWAY TESTING LABORATORIES. It may not be reproduced rather in its entirety or in part and it may not be used for advertising. The client to whom the report is issued may, however, show or send it . or a certified copy there of prepared by the SHENZHEN TIMEWAY TESTING LABORATORIES. to his customer. Supplier or others persons directly concerned. SHENZHEN TIMEWAY TESTING LABORATORIES. will not, without the consent of the client enter into any discussion of correspondence with any third party concerning the contents of the report.  
In the event of the improper use of the report. The SHENZHEN TIMEWAY TESTING LABORATORIES. reserves the rights to withdraw it and to adopt any other remedies which may be appropriate.



## 1.0 General Details

### 1.1 Test Lab Details

SHENZHEN TIMEWAY TESTING LABORATORIES

Zone C, 1st Floor, Block B, Jun Xiang Da Building, Zhongshan Park Road West, Tong Le Village, Nanshan District, Shenzhen, China

Tel: +86 755 83448688 Fax :+86 755 83442996

#### Test Location

**All tests were performed at:**

SHENZHEN TIMEWAY TESTING LABORATORIES

Zone C, 1st Floor, Block B, Jun Xiang Da Building, Zhongshan Park Road West, Tong Le Village, Nanshan District, Shenzhen, China

Tel: +86 755 83448688 Fax :+86 755 83442996

### 1.2 Applicant Details

Applicant: 2Service B.V.

Address: Santkamp 5, 6836 BE, Arnhem, The Netherlands.

Telephone: --

Fax: --

Manufacturer: 2Service B.V.

Address: Santkamp 5, 6836 BE, Arnhem, The Netherlands.

Telephone: --

Fax: --

### 1.3 Description of EUT

Product: Promiz ANC TWS Earbuds

Trademark: promiz

Model Number: PZ-60003

Adding Trademark: N/A

Adding Model Number: SS-TS139N

Battery: DC5V, 0.1A input or Built-in DC3.7V, 30mAh Li-ion battery for earphones and DC5V/1A input or Built-in DC3.7V, 300mAh Li-ion battery for charger base

### 1.4 Submitted Sample(s): 1 Samples

### 1.5 Test Duration

Date of Receipt of Application: January 07, 2022

Date of Test: January 07, 2022 ~ January 18, 2022

The report refers only to the sample tested and does not apply to the bulk.

This report is issued in confidence to the client and it will be strictly treated as such by the SHENZHEN TIMEWAY TESTING LABORATORIES. It may not be reproduced rather in its entirety or in part and it may not be used for advertising. The client to whom the report is issued may, however, show or send it . or a certified copy there of prepared by the SHENZHEN TIMEWAY TESTING LABORATORIES. to his customer. Supplier or others persons directly concerned. SHENZHEN TIMEWAY TESTING LABORATORIES. will not, without the consent of the client enter into any discussion of correspondence with any third party concerning the contents of the report.

In the event of the improper use of the report. The SHENZHEN TIMEWAY TESTING LABORATORIES. reserves the rights to withdraw it and to adopt any other remedies which may be appropriate.





## 2.0 List of Measurement Equipment

### 2.1 Conducted Emission Test

Name	Model No.	Serial No.	Manufacturer	Calibration Date	Calibration Cycle
EMI Test Receiver	ESH3	860905/006	RS	2021.06.18	1Year
Spectrum Analyzer	ESA-L1500A	US37451154	HP	2021.06.18	1Year
PULSE LIMITER	ESH3-Z2	100281	RS	2021.06.18	1Year
LISN	ESH3-Z5	100294	RS	2021.06.18	1Year
LISN	ESH3-Z5	100253	RS	2021.06.18	1Year
LISN	NNB42	00012	SCHAFFNER	2022.01.05	1Year

### 2.2 Radiated Disturbance Test

Name	Model No	Serial No.	Manufacturer	Calibration Date	Calibration Cycle
EMI Test Receiver	ESPI 3	100379	RS	2021.06.18	1Year
Spectrum Analyzer	E4407B	MY50441392	HP/Agilent	2021.06.18	1Year
Amplifier	BBV9743	#218	HP/Agilent	2021.06.18	1Year
Bilog Antenna	VULB9163	9163/340	Schwarebeck	2021.07.02	3Year
Horn Antenna	BBHA 9120D	9120D-631	RS	2021.07.02	3Year
Amplifier	8449B	3008A00160	HP/Agilent	2021.06.18	1Year

### 2.3 Harmonic & Flicker Test

Name	Model No.	Serial No.	Manufacturer	Calibration Date	Calibration Cycle
Harmonics Flicker Test System	PACS-1	72305	CI	2021.07.02	1Year
5K VA AC Power Source	5001iX	56060	CI	2021.07.02	N/A

### 2.4 ESD Test

Name	Model No.	Serial No.	Manufacturer	Calibration Date	Calibration Cycle
ESD Simulator	DITO	0404-24	EM TEST	2021.06.18	1Year

### 2.5 RF field Strength Susceptibility

Name	Model No.	Serial No.	Manufacturer	Calibration	Calibration
------	-----------	------------	--------------	-------------	-------------

The report refers only to the sample tested and does not apply to the bulk.

This report is issued in confidence to the client and it will be strictly treated as such by the SHENZHEN TIMEWAY TESTING LABORATORIES. It may not be reproduced rather in its entirety or in part and it may not be used for advertising. The client to whom the report is issued may, however, show or send it or a certified copy thereof prepared by the SHENZHEN TIMEWAY TESTING LABORATORIES to his customer. Supplier or others persons directly concerned. SHENZHEN TIMEWAY TESTING LABORATORIES will not, without the consent of the client enter into any discussion of correspondence with any third party concerning the contents of the report.

In the event of the improper use of the report. The SHENZHEN TIMEWAY TESTING LABORATORIES reserves the rights to withdraw it and to adopt any other remedies which may be appropriate.



				Date	Cycle
Signal Generator	SMT03	100059	RS	2021.06.18	1Year
Power Meter	NRVS	---	RS	2021.06.18	1Year
Voltage Probe	URV5-Z2	100012	RS	2021.06.18	1Year
Voltage Probe	URV5-Z2	100013	RS	2021.06.18	1Year
Power Amplifier	150W1000	300999	AR	2021.06.18	1Year
Power Amplifier	25S1G4AM1	305993	AR	2021.06.18	1Year
Field Probe	CBL6111C	2576	Holaday	2021.06.18	1Year
Bilog Antenna	MCDC	---	Chase	2021.06.18	1Year

#### 2.6 Electrical Fast Transient/Burst (EFT/B) Immunity test

Name	Model No.	Serial No.	Manufacturer	Calibration Date	Calibration Cycle
EFT Generator	UCS 500 M4	0304-42	EM TEST	2021.06.18	1Year
Power Source	MV2616	0104-14	EM TEST	2021.06.18	1Year

#### 2.7 Surge Test

Name	Model No.	Serial No.	Manufacturer	Calibration Date	Calibration Cycle
Ultra Compact Simulator	UCS 500 M4	0304-42	EM TEST	2021.06.18	1Year
Power Source	MV2616	0104-14	EM TEST	2021.06.18	1Year

#### 2.8 Conducted Immunity Test

Name	Model No.	Serial No.	Manufacturer	Calibration Date	Calibration Cycle
Continuous Wave Simulator	CWS 500C	0407-05	EM TEST	2021.06.18	1 Year

#### 2.9 Power-frequency Magnetic Field

Name	Model No.	Serial No.	Manufacturer	Calibration Date	Calibration Cycle
Continuous Wave Simulator	UCS 500 M4	0304-42	EM TEST	2021.06.18	1 Year
Power Source Network	MV 2616	0104-14	EM TEST	2021.06.18	1 Year

The report refers only to the sample tested and does not apply to the bulk.

This report is issued in confidence to the client and it will be strictly treated as such by the SHENZHEN TIMEWAY TESTING LABORATORIES. It may not be reproduced rather in its entirety or in part and it may not be used for advertising. The client to whom the report is issued may, however, show or send it or a certified copy thereof prepared by the SHENZHEN TIMEWAY TESTING LABORATORIES to his customer. Supplier or others persons directly concerned. SHENZHEN TIMEWAY TESTING LABORATORIES will not, without the consent of the client enter into any discussion of correspondence with any third party concerning the contents of the report.

In the event of the improper use of the report. The SHENZHEN TIMEWAY TESTING LABORATORIES reserves the rights to withdraw it and to adopt any other remedies which may be appropriate.



Current Transformer	MC2630	--	EM TEST	2021.06.18	1 Year
Magnetic Coil	MS100	0304-42	EM TEST	2021.06.18	1 Year

#### 2.10 Voltage Dips/Interruption Immunity Test

Name	Model No.	Serial No.	Manufacturer	Calibration Date	Calibration Cycle
Ultra Compact Simulator	UCS 500 M4	0304-42	EM TEST	2021.06.18	1Year
Power Source	MV2616	0104-14	EM TEST	2021.06.18	1Year

The report refers only to the sample tested and does not apply to the bulk.

This report is issued in confidence to the client and it will be strictly treated as such by the SHENZHEN TIMEWAY TESTING LABORATORIES. It may not be reproduced rather in its entirety or in part and it may not be used for advertising. The client to whom the report is issued may, however, show or send it . or a certified copy there of prepared by the SHENZHEN TIMEWAY TESTING LABORATORIES. to his customer. Supplier or others persons directly concerned. SHENZHEN TIMEWAY TESTING LABORATORIES. will not, without the consent of the client enter into any discussion of correspondence with any third party concerning the contents of the report.

In the event of the improper use of the report. The SHENZHEN TIMEWAY TESTING LABORATORIES. reserves the rights to withdraw it and to adopt any other remedies which may be appropriate.



**3.0 Technical Details**

**3.1 Investigations Requested**

Perform Electromagnetic Interference [EMI] & Electromagnetic Susceptibility [EMS] tests for CE Marking

**3.2 Test Standards**

Test Standards		
EN 55032:2015+A11:2020+A1:2020	Electromagnetic compatibility of multimedia equipment - Emission Requirements	
EN IEC 61000-3-2:2019+A1:2021	Electromagnetic compatibility(EMC)- Part 3-2:Limits-Limits for harmonic current emissions(equipment input current $\leq$ 16A per phase)	
EN 61000-3-3:2013+A1:2019	Electromagnetic compatibility (EMC)- Part 3-3: Limits-Limitation of voltage changes, Voltage fluctuations and flicker in public low-voltage supply systems. For equipment with rated current $\leq$ 16A per phase and not subject to conditional connection	
EN 55035:2017+A11:2020	Electromagnetic compatibility of multimedia equipment - Immunity requirements	
	EN 61000-4-2:2009	Electrostatic discharge
	EN 61000-4-3:2006	RF electromagnetic field disturbances
	EN 61000-4-4:2012	Electrical Fast transients
	EN 61000-4-5:2014	Surge
	EN 61000-4-6:2009	Conducted susceptibility
	EN 61000-4-8:2010	Power-frequency Magnetic Field
	EN 61000-4-11:2011	Dips/Voltage Interruption Variation

**3.3 Performance Criteria**

Criterion	Description
<b>A</b>	No change in operational mode or degradation of performance outside of specification and no change in stored parameters.
<b>B</b>	Degradation of performance allowed during the test the EUT returning to intended operation after the test.
<b>C</b>	Loss of function allowed during the test, provided that function is self recoverable or can be recovered by operation of controls.

The report refers only to the sample tested and does not apply to the bulk.  
 This report is issued in confidence to the client and it will be strictly treated as such by the SHENZHEN TIMEWAY TESTING LABORATORIES. It may not be reproduced rather in its entirety or in part and it may not be used for advertising. The client to whom the report is issued may, however, show or send it . or a certified copy there of prepared by the SHENZHEN TIMEWAY TESTING LABORATORIES. to his customer. Supplier or others persons directly concerned. SHENZHEN TIMEWAY TESTING LABORATORIES. will not, without the consent of the client enter into any discussion of correspondence with any third party concerning the contents of the report.  
 In the event of the improper use of the report. The SHENZHEN TIMEWAY TESTING LABORATORIES. reserves the rights to withdraw it and to adopt any other remedies which may be appropriate.



### 3.4 Test standards and Results Summary Tables

Test Condition	Test Requirement	Test Method	Test Result
<b>EMISSION Results Summary</b>			
Conducted Emission on AC Mains, 150kHz to 30MHz	EN 55032:2015 +A11:2020+A1:2020	EN 55032:2015 +A11:2020+A1:2020	Pass
Conducted Emission on at telecommunication ports, 150kHz to 30MHz	EN 55032:2015 +A11:2020+A1:2020	EN 55032:2015 +A11:2020+A1:2020	N/A
Radiated Emissions, 30MHz to 6GHz	EN 55032:2015 +A11:2020+A1:2020	EN 55032:2015 +A11:2020+A1:2020	Pass
Harmonic Emissions on AC supply	EN IEC 61000-3-2:2019+A1:2021	EN IEC 61000-3-2: 2019+A1:2021	N/A
Voltage fluctuations on AC supply	EN 61000-3-3:2013 +A1:2019	EN 61000-3-3:2013 +A1:2019	N/A
<b>IMMUNITY Results Summary</b>			
Electrostatic Discharge	EN 55035:2017+A11:2020	EN 61000-4-2: 2009	Pass
Continuous RF electromagnetic field disturbances	EN 55035:2017+A11:2020	EN 61000-4-3: 2006	Pass
Continuous induced RF disturbances	EN 55035:2017+A11:2020	EN 61000-4-6: 2009	Pass
Power frequency magnetic field	EN 55035:2017+A11:2020	EN 61000-4-8: 2010	N/A
Electrical fast transients/burst (EFT/B)	EN 55035:2017+A11:2020	EN 61000-4-4: 2012	Pass
Surges	EN 55035:2017+A11:2020	EN 61000-4-5: 2014	Pass
Voltage dips and interruptions	EN 55035:2017+A11:2020	EN 61000-4-11: 2011	Pass
Broadband impulsive conducted disturbances	EN 55035:2017+A11:2020	EN 61000-4-6: 2009	N/A

**Note: N/A-Not applicable**

The report refers only to the sample tested and does not apply to the bulk.  
This report is issued in confidence to the client and it will be strictly treated as such by the SHENZHEN TIMEWAY TESTING LABORATORIES. It may not be reproduced rather in its entirety or in part and it may not be used for advertising. The client to whom the report is issued may, however, show or send it . or a certified copy there of prepared by the SHENZHEN TIMEWAY TESTING LABORATORIES. to his customer. Supplier or others persons directly concerned. SHENZHEN TIMEWAY TESTING LABORATORIES. will not, without the consent of the client enter into any discussion of correspondence with any third party concerning the contents of the report.  
In the event of the improper use of the report. The SHENZHEN TIMEWAY TESTING LABORATORIES. reserves the rights to withdraw it and to adopt any other remedies which may be appropriate.



#### 4.0 Electromagnetic Interference Test results

##### 4.1 Power line Conducted Emission Test

###### 4.1.1 Schematics of the test

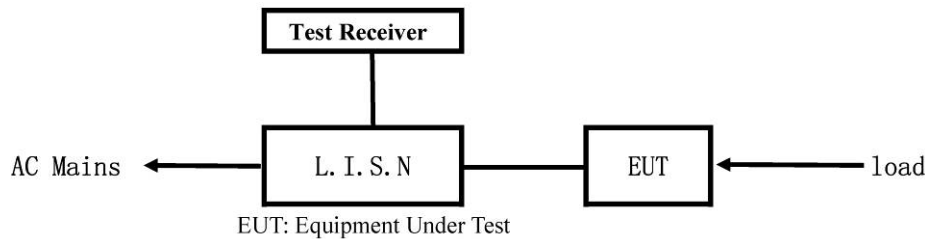

###### 4.1.2 Test Method:

The test was performed in accordance with EN 55032:2015+A11:2020+A1:2020

###### Block diagram of Test setup

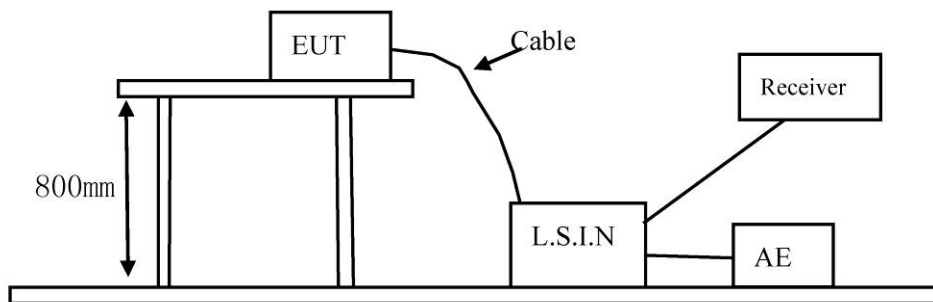

###### 4.1.3 Power line conducted Emission Limit

Frequency(MHz)	Limits dB(μV)			
	Class A Equipment		Class B Equipment	
	Quasi-peak Level	Average Level	Quasi-peak Level	Average Level
0.15 ~ 0.50	79.0	66.0	66.0~56.0*	56.0~46.0*
0.50 ~ 5.00	73.0	60.0	56.0	46.0
5.00 ~ 30.00	73.0	60.0	60.0	50.0

- Notes: 1. \*decreasing linearly with logarithm of frequency.  
 2. The lower limit shall apply at the transition frequencies

###### 4.1.4 Test Results

Limits for Conducted Emission test, Please refer to limit line (Quasi-peak)and Average in the following diagram labelled as (QP)&AV

**Remark:** Calculated measurement uncertainty=3.6dB

The report refers only to the sample tested and does not apply to the bulk.  
 This report is issued in confidence to the client and it will be strictly treated as such by the SHENZHEN TIMEWAY TESTING LABORATORIES. It may not be reproduced rather in its entirety or in part and it may not be used for advertising. The client to whom the report is issued may, however, show or send it . or a certified copy there of prepared by the SHENZHEN TIMEWAY TESTING LABORATORIES. to his customer. Supplier or others persons directly concerned. SHENZHEN TIMEWAY TESTING LABORATORIES. will not, without the consent of the client enter into any discussion of correspondence with any third party concerning the contents of the report.  
 In the event of the improper use of the report. The SHENZHEN TIMEWAY TESTING LABORATORIES. reserves the rights to withdraw it and to adopt any other remedies which may be appropriate.



**A: Conducted Emission on Live Terminal (150kHz to 30MHz)**

**EUT Operating Environment**

Temperature: 25°C Humidity: 65%RH Atmospheric Pressure: 101 kPa

**EUT set Condition: Charging + Discharging**

**Power: AC230V/50Hz**

**Equipment Level: Class B**

**Results: Pass**

Please refer to following diagram for individual

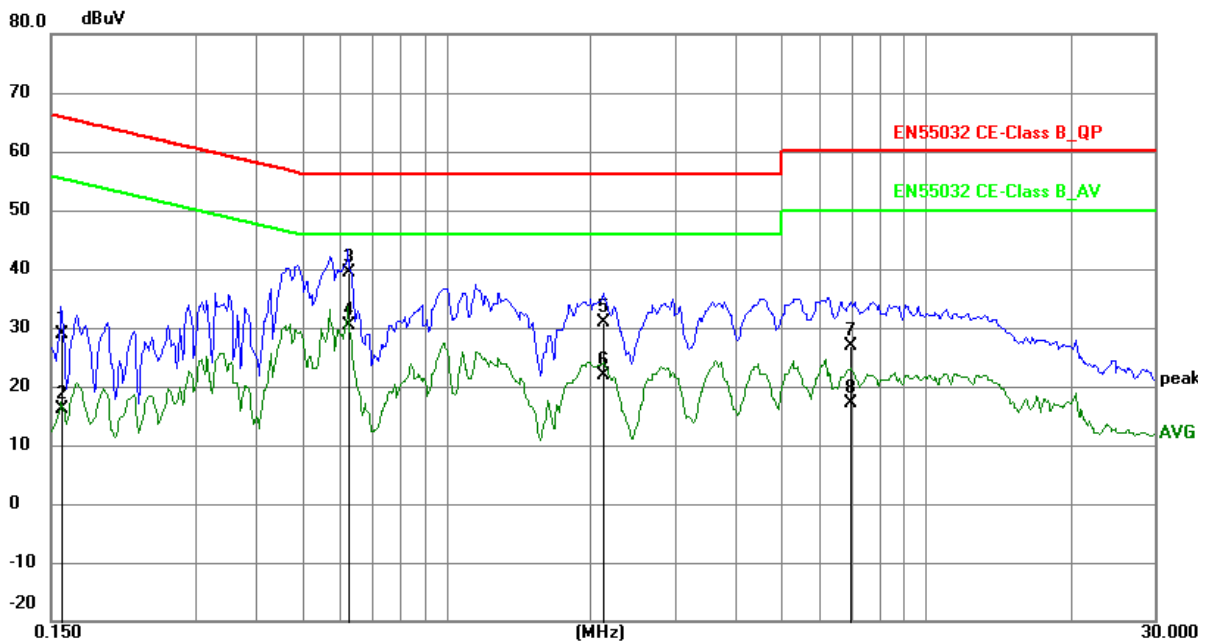

No.	Frequency (MHz)	Reading (dBuV)	Factor (dB)	Level (dBuV)	Limit (dBuV)	Margin (dB)	Detector	P/F	I
1	0.1578	19.14	9.78	28.92	65.58	-36.66	QP	P	
2	0.1578	6.42	9.78	16.20	55.58	-39.38	AVG	P	
3	0.6258	29.61	9.78	39.39	56.00	-16.61	QP	P	
4	0.6258	20.66	9.78	30.44	46.00	-15.56	AVG	P	
5	2.1312	21.11	9.81	30.92	56.00	-25.08	QP	P	
6	2.1312	12.08	9.81	21.89	46.00	-24.11	AVG	P	
7	6.9858	16.87	10.01	26.88	60.00	-33.12	QP	P	
8	6.9858	7.20	10.01	17.21	50.00	-32.79	AVG	P	

The report refers only to the sample tested and does not apply to the bulk.  
 This report is issued in confidence to the client and it will be strictly treated as such by the SHENZHEN TIMEWAY TESTING LABORATORIES. It may not be reproduced in its entirety or in part and it may not be used for advertising. The client to whom the report is issued may, however, show or send it or a certified copy thereof prepared by the SHENZHEN TIMEWAY TESTING LABORATORIES to his customer. Supplier or others persons directly concerned. SHENZHEN TIMEWAY TESTING LABORATORIES will not, without the consent of the client enter into any discussion of correspondence with any third party concerning the contents of the report.  
 In the event of the improper use of the report. The SHENZHEN TIMEWAY TESTING LABORATORIES reserves the rights to withdraw it and to adopt any other remedies which may be appropriate.



**B: Conducted Emission on Neutral Terminal (150kHz to 30MHz)**

**EUT Operating Environment**

Temperature: 25°C Humidity: 65%RH Atmospheric Pressure: 101 kPa

**EUT set Condition: Charging + Discharging**

**Power: AC230V/50Hz**

**Equipment Level: Class B**

**Results: Pass**

Please refer to following diagram for individual

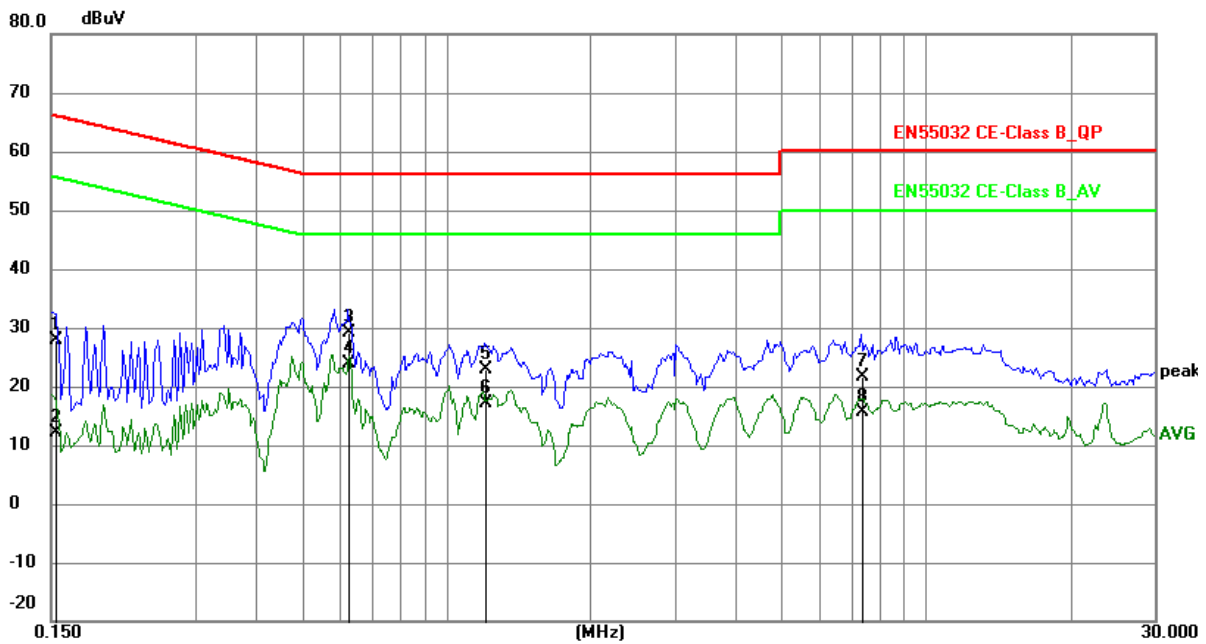

No.	Frequency (MHz)	Reading (dBuV)	Factor (dB)	Level (dBuV)	Limit (dBuV)	Margin (dB)	Detector	P/F
1	0.1539	18.11	9.78	27.89	65.79	-37.90	QP	P
2	0.1539	2.40	9.78	12.18	55.79	-43.61	AVG	P
3	0.6258	19.23	9.78	29.01	56.00	-26.99	QP	P
4	0.6258	14.19	9.78	23.97	46.00	-22.03	AVG	P
5	1.2069	13.06	9.79	22.85	56.00	-33.15	QP	P
6	1.2069	7.31	9.79	17.10	46.00	-28.90	AVG	P
7	7.3563	11.63	10.03	21.66	60.00	-38.34	QP	P
8	7.3563	5.53	10.03	15.56	50.00	-34.44	AVG	P

The report refers only to the sample tested and does not apply to the bulk.  
 This report is issued in confidence to the client and it will be strictly treated as such by the SHENZHEN TIMEWAY TESTING LABORATORIES. It may not be reproduced in its entirety or in part and it may not be used for advertising. The client to whom the report is issued may, however, show or send it or a certified copy thereof prepared by the SHENZHEN TIMEWAY TESTING LABORATORIES to his customer. Supplier or others persons directly concerned. SHENZHEN TIMEWAY TESTING LABORATORIES will not, without the consent of the client enter into any discussion of correspondence with any third party concerning the contents of the report.  
 In the event of the improper use of the report. The SHENZHEN TIMEWAY TESTING LABORATORIES reserves the rights to withdraw it and to adopt any other remedies which may be appropriate.



## 4.2 Telecommunication ports Conducted Emission Test

### 4.2.1 Schematics of the test

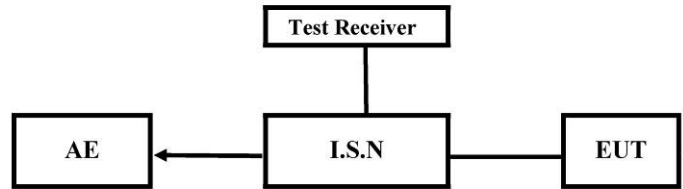

EUT: Equipment Under Test

### 4.2.2 Test Method:

The test was performed in accordance with EN 55032:2015+A11:2020+A1:2020

#### Block diagram of Test setup

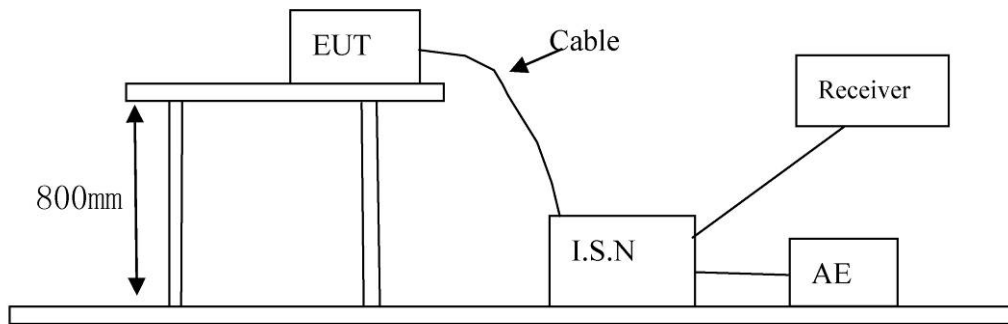

### 4.2.3 Telecommunication ports conducted Emission Limit

Frequency(MHz)	Class A Limits				Class B Limits			
	Quasi-peak Level		Average Level		Quasi-peak Level		Average Level	
	Voltage dB(uV)	Current dB(uA)	Voltage dB(uV)	Current dB(uA)	Voltage dB(uV)	Current dB(uA)	Voltage dB(uV)	Current dB(uA)
0.15 ~ 0.50	97 to 87	53 to 43	84 to 74	40 to 30	84 to 74	40 to 30	74 to 64	30 to 20
0.50 ~ 30.00	87	43	74	30	74	30	64	20

- Notes:
- \*decreasing linearly with logarithm of frequency.
  - The tighter limit shall apply at the transition frequencies

### 4.2.4 Test Results : N/A

Limits for Conducted Emission test, Please refer to limit line (Quasi-peak)and Average in the following diagram labelled as (QP)&AV

#### Remark:

Calculated measurement uncertainty=1.9dB

The report refers only to the sample tested and does not apply to the bulk.  
 This report is issued in confidence to the client and it will be strictly treated as such by the SHENZHEN TIMEWAY TESTING LABORATORIES. It may not be reproduced in its entirety or in part and it may not be used for advertising. The client to whom the report is issued may, however, show or send it or a certified copy thereof prepared by the SHENZHEN TIMEWAY TESTING LABORATORIES to his customer. Supplier or others persons directly concerned. SHENZHEN TIMEWAY TESTING LABORATORIES will not, without the consent of the client enter into any discussion of correspondence with any third party concerning the contents of the report.  
 In the event of the improper use of the report. The SHENZHEN TIMEWAY TESTING LABORATORIES reserves the rights to withdraw it and to adopt any other remedies which may be appropriate.



**A: Conducted Emission on Telecommunication port (150kHz to 30MHz)**

**EUT Operating Environment**

Temperature: 25°C      Humidity: 75 %RH      Atmospheric Pressure: 101 kPa

**EUT set Condition: Normal operation mode**

**Equipment Level: Class B**

**Results: N/A**

Please refer to following diagram for individual

Frequency (MHz)	Port	Reading(dB $\mu$ V)		Limit(dB $\mu$ V)	
		Quasi-peak	Average	Quasi-peak	Average

The report refers only to the sample tested and does not apply to the bulk.  
This report is issued in confidence to the client and it will be strictly treated as such by the SHENZHEN TIMEWAY TESTING LABORATORIES. It may not be reproduced rather in its entirety or in part and it may not be used for advertising. The client to whom the report is issued may, however, show or send it . or a certified copy there of prepared by the SHENZHEN TIMEWAY TESTING LABORATORIES. to his customer. Supplier or others persons directly concerned. SHENZHEN TIMEWAY TESTING LABORATORIES. will not, without the consent of the client enter into any discussion of correspondence with any third party concerning the contents of the report.  
In the event of the improper use of the report. The SHENZHEN TIMEWAY TESTING LABORATORIES. reserves the rights to withdraw it and to adopt any other remedies which may be appropriate.



**B: Conducted Emission on Telecommunication port (150kHz to 30MHz)**

**EUT Operating Environment**

Temperature: 25°C      Humidity: 75 %RH      Atmospheric Pressure: 101 kPa

**EUT set Condition: Normal operation mode**

**Equipment Level: Class B**

**Results: N/A**

Please refer to following diagram for individual

Frequency (MHz)	Port	Reading(dB $\mu$ A)		Limit(dB $\mu$ A)	
		Quasi-peak	Average	Quasi-peak	Average

**Note: This test item is not applicable because there is no telecommunication port**

The report refers only to the sample tested and does not apply to the bulk.  
This report is issued in confidence to the client and it will be strictly treated as such by the SHENZHEN TIMEWAY TESTING LABORATORIES. It may not be reproduced rather in its entirety or in part and it may not be used for advertising. The client to whom the report is issued may, however, show or send it . or a certified copy there of prepared by the SHENZHEN TIMEWAY TESTING LABORATORIES. to his customer. Supplier or others persons directly concerned. SHENZHEN TIMEWAY TESTING LABORATORIES. will not, without the consent of the client enter into any discussion of correspondence with any third party concerning the contents of the report.  
In the event of the improper use of the report. The SHENZHEN TIMEWAY TESTING LABORATORIES. reserves the rights to withdraw it and to adopt any other remedies which may be appropriate.



### 4.3 Radiated Disturbance Test

#### 4.3.1 Schematics of the test



#### 4.3.2 Test Method:

The test was performed in accordance with EN 55032:2015+A11:2020+A1:2020

#### Block diagram of Test setup

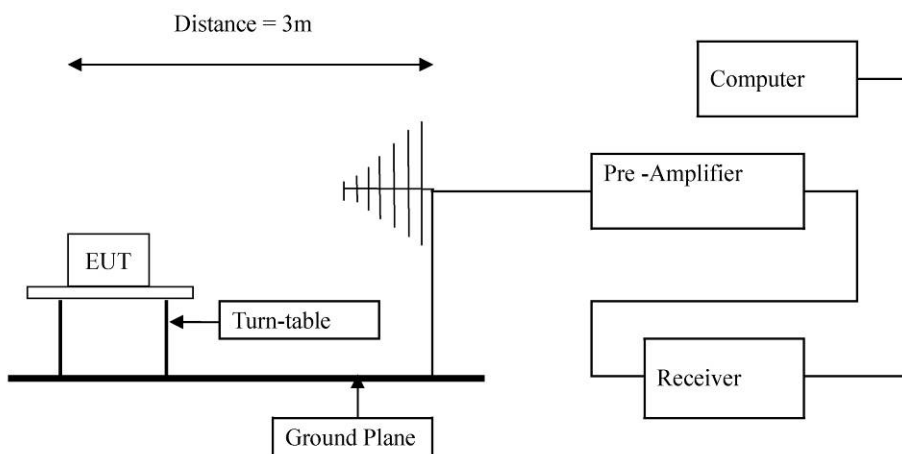

#### 4.3.3 Radiated Disturbance Test Limit

Frequency Range (MHz)	Quasi-Peak limits (dB $\mu$ V/m)	
	Class A Limits	Class B Limits
30-230	50.00	40.00
230-1000	57.00	47.00
1000-3000	56(AV)/76(PK)	50(AV)/70(PK)
3000-6000	60(AV)/80(PK)	54(AV)/74(PK)

Note: The lower limit shall apply at the transition frequencies

#### 4.3.4 Test result

Limits for Radiated Disturbance test, Please refer to limit line (Quasi-peak) in the following diagram labelled as (QP)

#### Remark:

Calculated measurement uncertainty=4.7dB

The report refers only to the sample tested and does not apply to the bulk.  
This report is issued in confidence to the client and it will be strictly treated as such by the SHENZHEN TIMEWAY TESTING LABORATORIES. It may not be reproduced in its entirety or in part and it may not be used for advertising. The client to whom the report is issued may, however, show or send it or a certified copy thereof prepared by the SHENZHEN TIMEWAY TESTING LABORATORIES to his customer. Supplier or others persons directly concerned. SHENZHEN TIMEWAY TESTING LABORATORIES will not, without the consent of the client enter into any discussion of correspondence with any third party concerning the contents of the report.  
In the event of the improper use of the report. The SHENZHEN TIMEWAY TESTING LABORATORIES reserves the rights to withdraw it and to adopt any other remedies which may be appropriate.



**A: Radiated Disturbance (30MHz----1000MHz)**

Project Number:	CASE4	Test Time:	2022-01-08_15.35.08
EUT Name:	Promiz ANC TWS Earbuds	Test Engineer:	LUCK
Manufacturer:	2Service B.V.	Test Standard:	EN 55032
Model:	PZ-60003	Work Addition:	Charging + Discharging
Temp.(oC):	25	Load:	
Hum.:	65%	Remark:	

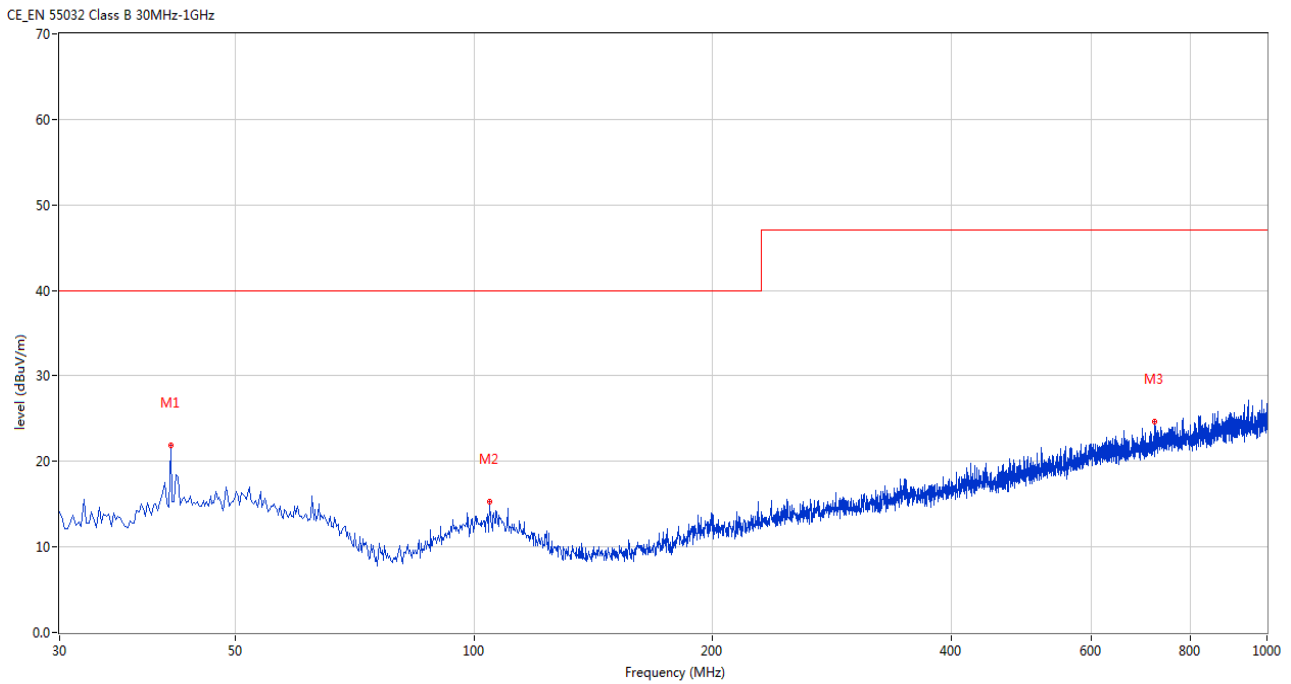

No.	Frequency (MHz)	Results (dBuV/m)	Factor (dB)	Limit (dBuV/m)	Over Limit (dB)	Detector	Table (o)	Height (cm)	ANT	Verdict
1	41.395	21.86	-11.91	40.0	-18.14	Peak	252.00	100	Horizontal	Pass
2	104.671	15.30	-13.25	40.0	-24.70	Peak	283.00	100	Horizontal	Pass
3	721.437	24.61	-3.93	47.0	-22.39	Peak	257.00	100	Horizontal	Pass

The report refers only to the sample tested and does not apply to the bulk.  
 This report is issued in confidence to the client and it will be strictly treated as such by the SHENZHEN TIMEWAY TESTING LABORATORIES. It may not be reproduced rather in its entirety or in part and it may not be used for advertising. The client to whom the report is issued may, however, show or send it . or a certified copy there of prepared by the SHENZHEN TIMEWAY TESTING LABORATORIES. to his customer. Supplier or others persons directly concerned. SHENZHEN TIMEWAY TESTING LABORATORIES. will not, without the consent of the client enter into any discussion of correspondence with any third party concerning the contents of the report.  
 In the event of the improper use of the report. The SHENZHEN TIMEWAY TESTING LABORATORIES. reserves the rights to withdraw it and to adopt any other remedies which may be appropriate.



**B: Radiated Disturbance (30MHz----1000MHz)**

Project Number:	CASE4	Test Time:	2022-01-08_15.37.48
EUT Name:	Promiz ANC TWS Earbuds	Test Engineer:	LUCK
Manufacturer:	2Service B.V.	Test Standard:	EN 55032
Model:	PZ-60003	Work Addition:	Charging + Discharging
Temp.(oC):	25	Load:	
Hum.:	65%	Remark:	

CE\_EN 55032 Class B 30MHz-1GHz

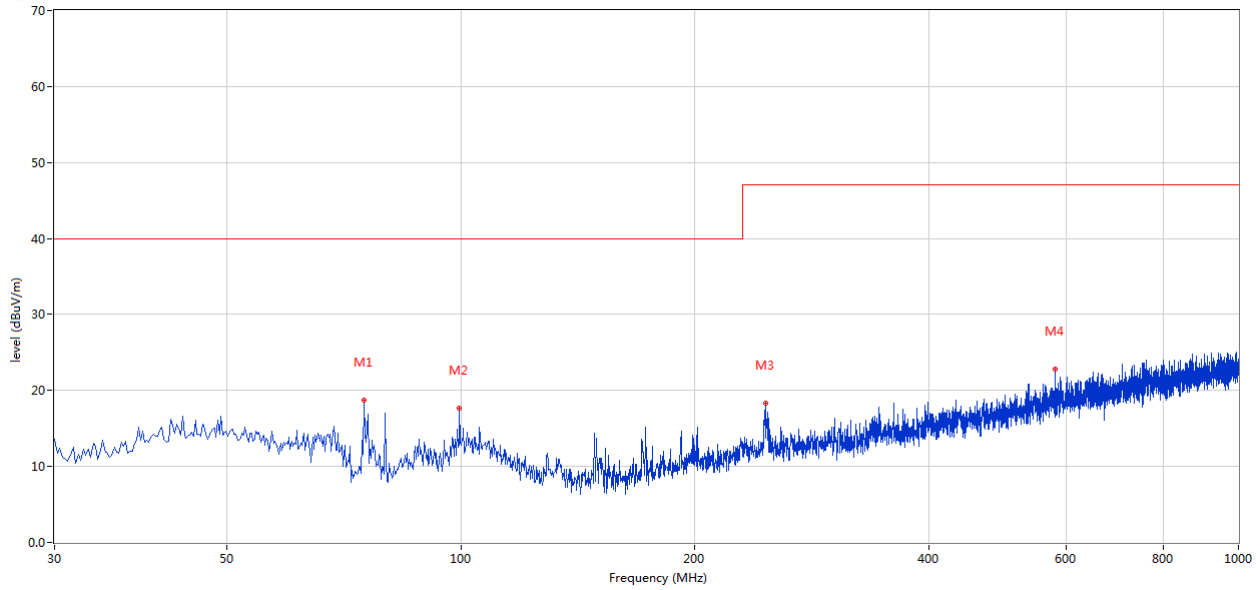

No.	Frequency (MHz)	Results (dBuV/m)	Factor (dB)	Limit (dBuV/m)	Over Limit (dB)	Detector	Table (o)	Height (cm)	ANT	Verdict
1	75.094	18.68	-17.33	40.0	-21.32	Peak	26.00	100	Vertical	Pass
2	99.580	17.67	-13.60	40.0	-22.33	Peak	26.00	100	Vertical	Pass
3	246.256	18.38	-12.17	47.0	-28.62	Peak	26.00	100	Vertical	Pass
4	581.065	22.82	-5.63	47.0	-24.18	Peak	5.00	100	Vertical	Pass

The report refers only to the sample tested and does not apply to the bulk.  
 This report is issued in confidence to the client and it will be strictly treated as such by the SHENZHEN TIMEWAY TESTING LABORATORIES. It may not be reproduced rather in its entirety or in part and it may not be used for advertising. The client to whom the report is issued may, however, show or send it . or a certified copy there of prepared by the SHENZHEN TIMEWAY TESTING LABORATORIES. to his customer. Supplier or others persons directly concerned. SHENZHEN TIMEWAY TESTING LABORATORIES. will not, without the consent of the client enter into any discussion of correspondence with any third party concerning the contents of the report.  
 In the event of the improper use of the report. The SHENZHEN TIMEWAY TESTING LABORATORIES. reserves the rights to withdraw it and to adopt any other remedies which may be appropriate.



#### 4.4 Harmonic Current Emission Test

##### 4.4.1 Schematic of the test

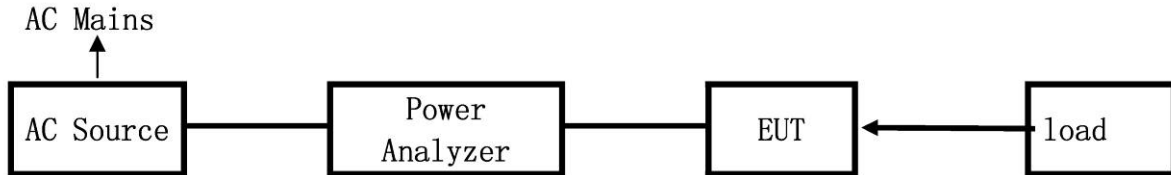

EUT: Equipment Under Test

##### 4.4.2 Test Method:

The test was performed in accordance with EN IEC 61000-3-2:2019+A1:2021

##### Block diagram of Test setup

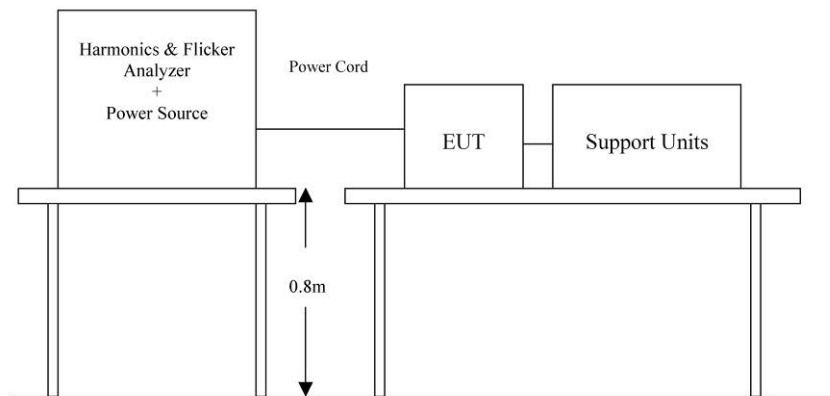

##### 4.4.3 Limits of Harmonic Current Emission For Class A

The report refers only to the sample tested and does not apply to the bulk.  
This report is issued in confidence to the client and it will be strictly treated as such by the SHENZHEN TIMEWAY TESTING LABORATORIES. It may not be reproduced in its entirety or in part and it may not be used for advertising. The client to whom the report is issued may, however, show or send it, or a certified copy thereof prepared by the SHENZHEN TIMEWAY TESTING LABORATORIES, to his customer, Supplier or other persons directly concerned. SHENZHEN TIMEWAY TESTING LABORATORIES, will not, without the consent of the client enter into any discussion of correspondence with any third party concerning the contents of the report.  
In the event of the improper use of the report, The SHENZHEN TIMEWAY TESTING LABORATORIES, reserves the rights to withdraw it and to adopt any other remedies which may be appropriate.



Harmonic order n	Maximum permissible harmonic current A
<b>Odd harmonics</b>	
3	2,30
5	1,14
7	0,77
9	0,40
11	0,33
13	0,21
15 ≤ n ≤ 39	0,15 $\frac{15}{n}$
<b>Even harmonics</b>	
2	1,08
4	0,43
6	0,30
8 ≤ n ≤ 40	0,23 $\frac{8}{n}$

#### 4.4.4 Test Results

Please refer to the following pages

##### Harmonic Current Emission Test

##### EUT Operating Environment

Temperature: 25°C      Humidity: 53%RH      Atmospheric Pressure: 101 kPa

##### EUT set Condition:

**Results: N/A**

N/A ---the input power less than 75W.

Please refer to following diagram for individual

Harmonic results as a% of the limits

No	(Test result/Limit) %	No	(Test result/Limit) %	No	(Test result/Limit) %	No	(Test result/Limit) %
1		11		21		31	
2		12		22		32	
3		13		23		33	
4		14		24		34	
5		15		25		35	
6		16		26		36	
7		17		27		37	
8		18		28		38	
9		19		29		39	
10		20		30		40	

The report refers only to the sample tested and does not apply to the bulk.

This report is issued in confidence to the client and it will be strictly treated as such by the SHENZHEN TIMEWAY TESTING LABORATORIES. It may not be reproduced rather in its entirety or in part and it may not be used for advertising. The client to whom the report is issued may, however, show or send it . or a certified copy there of prepared by the SHENZHEN TIMEWAY TESTING LABORATORIES. to his customer. Supplier or others persons directly concerned. SHENZHEN TIMEWAY TESTING LABORATORIES. will not, without the consent of the client enter into any discussion of correspondence with any third party concerning the contents of the report.

In the event of the improper use of the report. The SHENZHEN TIMEWAY TESTING LABORATORIES. reserves the rights to withdraw it and to adopt any other remedies which may be appropriate.



#### 4.5 Voltage Fluctuations & Flicker Test

##### 4.5.1 Schematic of the test

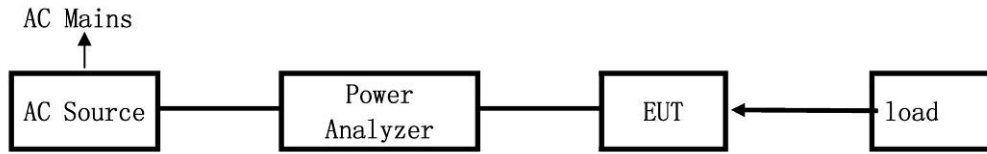

EUT: Equipment Under Test

##### 4.5.2 Test Method:

The test was performed in accordance with EN 61000-3-3:2013+A1:2019

##### Block diagram of Test setup

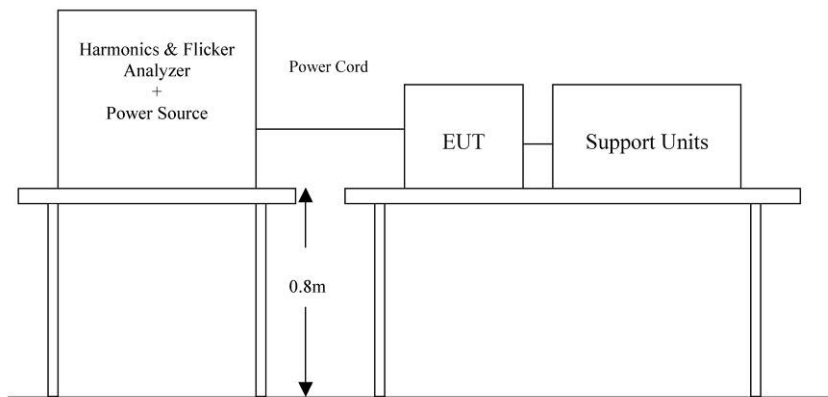

##### 4.5.3 Test Results

Result: N/A

The report refers only to the sample tested and does not apply to the bulk.

This report is issued in confidence to the client and it will be strictly treated as such by the SHENZHEN TIMEWAY TESTING LABORATORIES. It may not be reproduced in its entirety or in part and it may not be used for advertising. The client to whom the report is issued may, however, show or send it or a certified copy thereof prepared by the SHENZHEN TIMEWAY TESTING LABORATORIES to his customer, Supplier or others persons directly concerned. SHENZHEN TIMEWAY TESTING LABORATORIES will not, without the consent of the client enter into any discussion of correspondence with any third party concerning the contents of the report.

In the event of the improper use of the report. The SHENZHEN TIMEWAY TESTING LABORATORIES reserves the rights to withdraw it and to adopt any other remedies which may be appropriate.



**5.0 Immunity Test**

**5.1 Electrostatic Discharge**

**5.1.1 Schematic of the test**

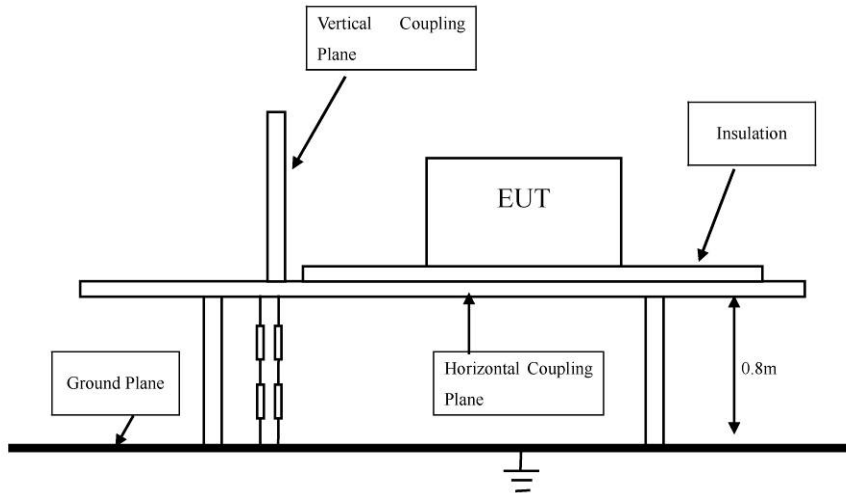

**5.1.2 Test method**

The test was performed in accordance with EN 61000-4-2: 2009

**5.1.3 Test severity**

±4kV for direct & in-direct Contact Discharge

±8kV for air Discharge

Performance Criterion Require: **B** (Please see following table)

**5.1.4 Susceptibility performance Criteria and Severity level**

Criterion	Description
<b>A</b>	No change in operational mode or degradation of performance outside of specification and no change in stored parameters.
<b>B</b>	Degradation of performance allowed during the test the EUT returning to intended operation after the test.
<b>C</b>	Loss of function allowed during the test, provided that function is self recoverable or can be recovered by operation of controls.

**Severity Level**

Level	Test Voltage Direct & in-direct contact Discharge (kV)	Test Voltage Air discharge(kV)
1	±2kV	±2kV
2	±4kV	±4kV
3	±6kV	±8kV
4	±8kV	±15kV

The report refers only to the sample tested and does not apply to the bulk. This report is issued in confidence to the client and it will be strictly treated as such by the SHENZHEN TIMEWAY TESTING LABORATORIES. It may not be reproduced rather in its entirety or in part and it may not be used for advertising. The client to whom the report is issued may, however, show or send it . or a certified copy there of prepared by the SHENZHEN TIMEWAY TESTING LABORATORIES. to his customer. Supplier or others persons directly concerned. SHENZHEN TIMEWAY TESTING LABORATORIES. will not, without the consent of the client enter into any discussion of correspondence with any third party concerning the contents of the report. In the event of the improper use of the report. The SHENZHEN TIMEWAY TESTING LABORATORIES. reserves the rights to withdraw it and to adopt any other remedies which may be appropriate.



### 5.1.5 Test Result

#### EUT Operating Environment

Temperature: 25°C      Humidity: 53%RH      Atmospheric Pressure: 101 kPa

Please refer to the following table for individual results.

Location	Discharge Method	Test Voltage	Results
HCP (Horizontal coupling plane)	In-Direct	$\pm 2\text{kV}, \pm 4\text{kV}$	Pass
VCP (Vertical Coupling plane)	In-Direct	$\pm 2\text{kV}, \pm 4\text{kV}$	Pass
Type-C Port	Contact Discharge	$\pm 2\text{kV}, \pm 4\text{kV}$	Pass
Charging Pins	Contact Discharge	$\pm 2\text{kV}, \pm 4\text{kV}$	Pass
Enclosure	Air Discharge	$\pm 2\text{kV}, \pm 4\text{kV}, \pm 8\text{kV}$	Pass
Gap	Air Discharge	$\pm 2\text{kV}, \pm 4\text{kV}, \pm 8\text{kV}$	Pass

**Remark:** Calculated measurement uncertainty= 0.2kV

The report refers only to the sample tested and does not apply to the bulk.  
This report is issued in confidence to the client and it will be strictly treated as such by the SHENZHEN TIMEWAY TESTING LABORATORIES. It may not be reproduced rather in its entirety or in part and it may not be used for advertising. The client to whom the report is issued may, however, show or send it . or a certified copy there of prepared by the SHENZHEN TIMEWAY TESTING LABORATORIES. to his customer. Supplier or others persons directly concerned. SHENZHEN TIMEWAY TESTING LABORATORIES. will not, without the consent of the client enter into any discussion of correspondence with any third party concerning the contents of the report.  
In the event of the improper use of the report. The SHENZHEN TIMEWAY TESTING LABORATORIES. reserves the rights to withdraw it and to adopt any other remedies which may be appropriate.



**5.2 RF field strength susceptibility (80MHz-1000MHz, 1800MHz, 2600MHz, 3500MHz, 5000MHz)**

**5.2.1 Schematics of the test**

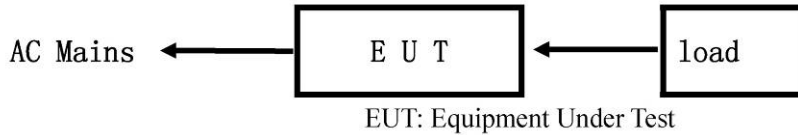

**5.2.2 Test Method:**

The test was performed in accordance with EN 61000-4-3:2006

Severity: Level 2 (3V/m)

Modulation: 80% AM

Performance Criterion Require: A (Please see following table)

**Block diagram of Test setup**

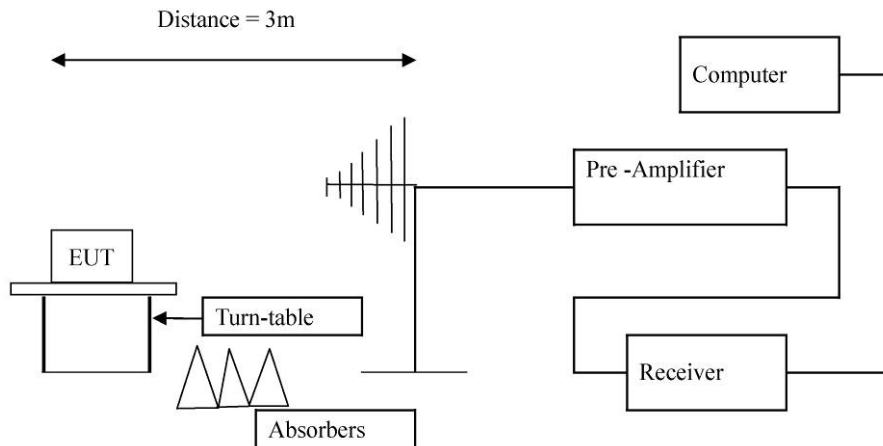

**5.2.3 Susceptibility performance Criteria and severity Level**

Susceptibility performance Criteria

Criterion	Description
<b>A</b>	No change in operational mode or degradation of performance outside of specification and no change in stored parameters.
<b>B</b>	Degradation of performance allowed during the test the EUT returning to intended operation after the test.
<b>C</b>	Loss of function allowed during the test, provided that function is self recoverable or can be recovered by operation of controls.

**Severity Level**

Level	Field Strength (V/m)
1	1
2	3
3	10

The report refers only to the sample tested and does not apply to the bulk.  
 This report is issued in confidence to the client and it will be strictly treated as such by the SHENZHEN TIMEWAY TESTING LABORATORIES. It may not be reproduced rather in its entirety or in part and it may not be used for advertising. The client to whom the report is issued may, however, show or send it or a certified copy thereof prepared by the SHENZHEN TIMEWAY TESTING LABORATORIES to his customer. Supplier or others persons directly concerned. SHENZHEN TIMEWAY TESTING LABORATORIES will not, without the consent of the client enter into any discussion of correspondence with any third party concerning the contents of the report.  
 In the event of the improper use of the report. The SHENZHEN TIMEWAY TESTING LABORATORIES reserves the rights to withdraw it and to adopt any other remedies which may be appropriate.



**5.2.4 Test Result:**

**EUT Operating Environment**

Temperature: 25°C      Humidity: 75%RH      Atmospheric Pressure: 101 kPa

Please refer to the following table for individual results.

Frequency (MHz)	Face	Polarity	Level (V/m)	Dwell Time(s)	Sweep Rate (%)	Results
80-10 0	0°	Horizontal	3	1	1	Pass
80-1000	90°	Horizontal	3	1	1	Pass
80-1000	180°	Horizontal	3	1	1	Pass
80-1000	270°	Horizontal	3	1	1	Pass
80-1000	0°	Vertical	3	1	1	Pass
80-1000	90°	Vertical	3	1	1	Pass
80-1000	180°	Vertical	3	1	1	Pass
80-1000	270°	Vertical	3	1	1	Pass
1800, 2600, 3500, 5000	0°	Horizontal	3	1	1	Pass
	90°	Horizontal	3	1	1	Pass
	180°	Horizontal	3	1	1	Pass
	270°	Horizontal	3	1	1	Pass
1800, 2600, 3500, 5000	0°	Vertical	3	1	1	Pass
	90°	Vertical	3	1	1	Pass
	180°	Vertical	3	1	1	Pass
	270°	Vertical	3	1	1	Pass

The report refers only to the sample tested and does not apply to the bulk.  
 This report is issued in confidence to the client and it will be strictly treated as such by the SHENZHEN TIMEWAY TESTING LABORATORIES. It may not be reproduced in its entirety or in part and it may not be used for advertising. The client to whom the report is issued may, however, show or send it, or a certified copy thereof prepared by the SHENZHEN TIMEWAY TESTING LABORATORIES, to his customer, Supplier or other persons directly concerned. SHENZHEN TIMEWAY TESTING LABORATORIES, will not, without the consent of the client enter into any discussion of correspondence with any third party concerning the contents of the report.  
 In the event of the improper use of the report, The SHENZHEN TIMEWAY TESTING LABORATORIES, reserves the rights to withdraw it and to adopt any other remedies which may be appropriate.



**5.3 Electrical Fast Transient/Burst (EFT/B) immunity test**

**5.3.1 Schematics of the test**



**5.3.2 Test Method**

The test was performed in accordance with EN 61000-4-4:2012

Severity: Level 2 (1kV)

Performance Criterion Require: **B** (Please see following table)

**Block diagram of Test setup**

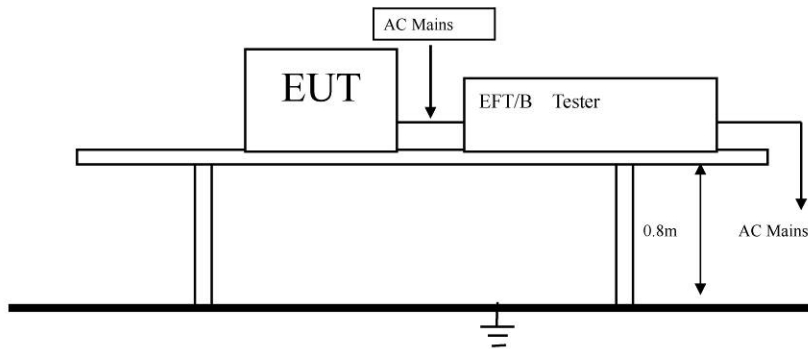

**5.3.3 Susceptibility performance Criteria and Severity Level**

Criterion	Description
<b>A</b>	No change in operational mode or degradation of performance outside of specification and no change in stored parameters.
<b>B</b>	Degradation of performance allowed during the test the EUT returning to intended operation after the test.
<b>C</b>	Loss of function allowed during the test, provided that function is self recoverable or can be recovered by operation of controls.

**Severity Level**

Level	Open Circuit output Test Voltage $\pm 10\%$	
	On power Supply Lines	On I/O (Input/output) Signal data and control lines
1	0.5kV	0.5kV
2	1kV	1kV
3	2kV	2kV
4	4kV	4kV
X	Special	Special

The report refers only to the sample tested and does not apply to the bulk.  
 This report is issued in confidence to the client and it will be strictly treated as such by the SHENZHEN TIMEWAY TESTING LABORATORIES. It may not be reproduced rather in its entirety or in part and it may not be used for advertising. The client to whom the report is issued may, however, show or send it . or a certified copy there of prepared by the SHENZHEN TIMEWAY TESTING LABORATORIES. to his customer. Supplier or others persons directly concerned. SHENZHEN TIMEWAY TESTING LABORATORIES. will not, without the consent of the client enter into any discussion of correspondence with any third party concerning the contents of the report.  
 In the event of the improper use of the report. The SHENZHEN TIMEWAY TESTING LABORATORIES. reserves the rights to withdraw it and to adopt any other remedies which may be appropriate.



### 5.3.4 Test Results

#### EUT Operating Environment

Temperature: 25°C      Humidity: 75%RH      Atmospheric Pressure: 101 kPa

Please refer to the following table for individual results.

Inject location: AC mains

Inject Line	Voltage kV	Inject Times (s)	Method	Results
L	± 1	120	Direct	Pass
N	± 1	120	Direct	Pass
L-N	± 1	120	Direct	Pass

The report refers only to the sample tested and does not apply to the bulk.

This report is issued in confidence to the client and it will be strictly treated as such by the SHENZHEN TIMEWAY TESTING LABORATORIES. It may not be reproduced rather in its entirety or in part and it may not be used for advertising. The client to whom the report is issued may, however, show or send it . or a certified copy there of prepared by the SHENZHEN TIMEWAY TESTING LABORATORIES. to his customer. Supplier or others persons directly concerned. SHENZHEN TIMEWAY TESTING LABORATORIES. will not, without the consent of the client enter into any discussion of correspondence with any third party concerning the contents of the report.

In the event of the improper use of the report. The SHENZHEN TIMEWAY TESTING LABORATORIES. reserves the rights to withdraw it and to adopt any other remedies which may be appropriate.



**5.4 Surge test**

**5.4.1 Schematics of the test**



**5.4.2 Test Method:**

The test was performed in accordance with EN 61000-4-5:2014

Severity: Level 2 (Line to Neutral at 1kV)

Performance Criterion Require: B (Please see following table)

**Block diagram of Test setup**

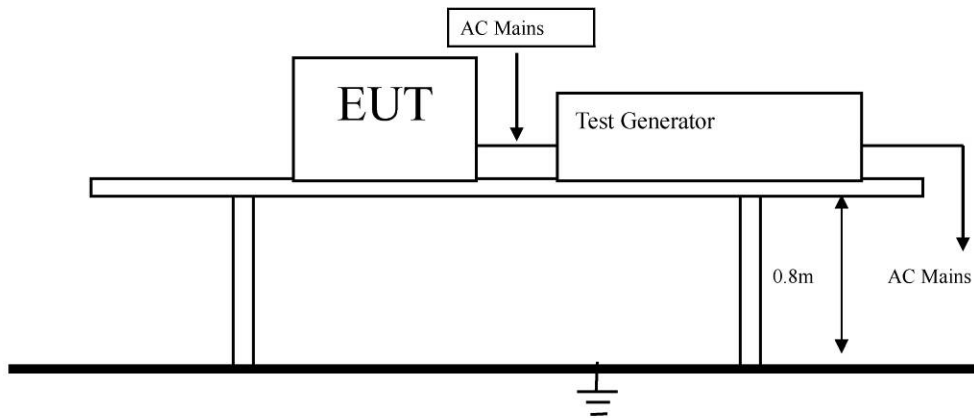

**5.4.3 Susceptibility performance Criteria and Severity Level**

Susceptibility performance Criteria

Criterion	Description
<b>A</b>	No change in operational mode or degradation of performance outside of specification and no change in stored parameters.
<b>B</b>	Degradation of performance allowed during the test the EUT returning to intended operation after the test.
<b>C</b>	Loss of function allowed during the test, provided that function is self recoverable or can be recovered by operation of controls.

The report refers only to the sample tested and does not apply to the bulk.  
 This report is issued in confidence to the client and it will be strictly treated as such by the SHENZHEN TIMEWAY TESTING LABORATORIES. It may not be reproduced in its entirety or in part and it may not be used for advertising. The client to whom the report is issued may, however, show or send it or a certified copy thereof prepared by the SHENZHEN TIMEWAY TESTING LABORATORIES to his customer. Supplier or others persons directly concerned. SHENZHEN TIMEWAY TESTING LABORATORIES will not, without the consent of the client enter into any discussion of correspondence with any third party concerning the contents of the report.  
 In the event of the improper use of the report. The SHENZHEN TIMEWAY TESTING LABORATORIES reserves the rights to withdraw it and to adopt any other remedies which may be appropriate.



Severity Level

Severity Level	Open-Circuit Test Voltage kV
1	0.5
2	1.0
3	2.0
4	4.0
*	Special

**5.4.4 Test Results**

**EUT Operating Environment**

Temperature: 25°C      Humidity: 75%RH      Atmospheric Pressure: 101 kPa

Please refer to the following table for individual results.

Test location:

Location	Polarity	Phase Angle	No of Pulse	Pulse Voltage(kV)	Results
L-N	±	90	5	1.0	Pass
	±	270	5	1.0	Pass

The report refers only to the sample tested and does not apply to the bulk.  
 This report is issued in confidence to the client and it will be strictly treated as such by the SHENZHEN TIMEWAY TESTING LABORATORIES. It may not be reproduced rather in its entirety or in part and it may not be used for advertising. The client to whom the report is issued may, however, show or send it . or a certified copy there of prepared by the SHENZHEN TIMEWAY TESTING LABORATORIES. to his customer. Supplier or others persons directly concerned. SHENZHEN TIMEWAY TESTING LABORATORIES. will not, without the consent of the client enter into any discussion of correspondence with any third party concerning the contents of the report.  
 In the event of the improper use of the report. The SHENZHEN TIMEWAY TESTING LABORATORIES. reserves the rights to withdraw it and to adopt any other remedies which may be appropriate.



**5.5 Conducted Immunity test**

**5.5.1 Schematics of the test**

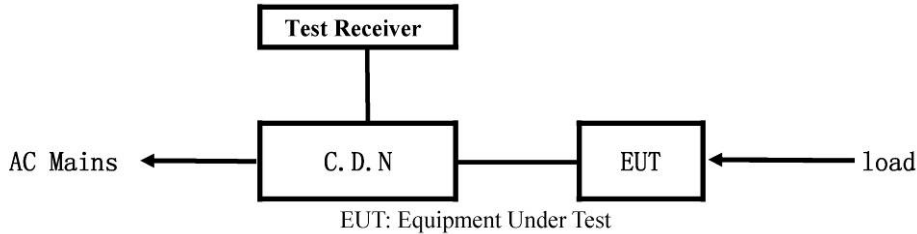

**5.5.2 Test Method**

The test was performed in accordance with EN 61000-4-6:2009  
 Severity: Level 2 (3 V rms),0.15MHz—80MHz  
 Performance Criterion Require: A (Please see following table)

**Block diagram of Test setup**

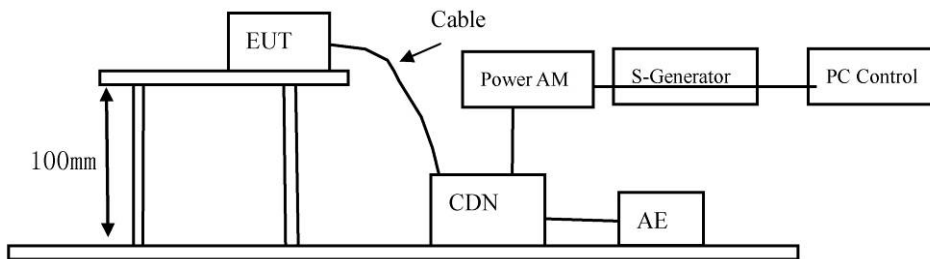

**5.5.3 Susceptibility performance Criteria and Severity Level**

Susceptibility performance Criteria

Criterion	Description
<b>A</b>	No change in operational mode or degradation of performance outside of specification and no change in stored parameters.
<b>B</b>	Degradation of performance allowed during the test the EUT returning to intended operation after the test.
<b>C</b>	Loss of function allowed during the test, provided that function is self recoverable or can be recovered by operation of controls.

Severity Level

Severity Level	Voltage Level (e.m.f) V
1	1
2	3
3	10
*	Special

The report refers only to the sample tested and does not apply to the bulk.  
 This report is issued in confidence to the client and it will be strictly treated as such by the SHENZHEN TIMEWAY TESTING LABORATORIES. It may not be reproduced rather in its entirety or in part and it may not be used for advertising. The client to whom the report is issued may, however, show or send it . or a certified copy there of prepared by the SHENZHEN TIMEWAY TESTING LABORATORIES. to his customer. Supplier or others persons directly concerned. SHENZHEN TIMEWAY TESTING LABORATORIES. will not, without the consent of the client enter into any discussion of correspondence with any third party concerning the contents of the report.  
 In the event of the improper use of the report. The SHENZHEN TIMEWAY TESTING LABORATORIES. reserves the rights to withdraw it and to adopt any other remedies which may be appropriate.



**5.5.4 Test Results:**

**EUT Operating Environment**

Temperature: 25°C      Humidity: 75%RH      Atmospheric Pressure: 101 KPa

Please refer to the following table for individual results.

Frequency Range (MHz)	Injected Position	Strength	Criterion	Result
0.15 - 10	AC Line	3V (rms)	A	Pass
10 - 30	AC Line	3 to 1V (rms)	A	Pass
30-80	AC Line	1V (rms)	A	Pass

Note: the amplitude of a test level varies over a given frequency range, it changes linearly with respect to the logarithm of the frequency

The report refers only to the sample tested and does not apply to the bulk.  
This report is issued in confidence to the client and it will be strictly treated as such by the SHENZHEN TIMEWAY TESTING LABORATORIES. It may not be reproduced rather in its entirety or in part and it may not be used for advertising. The client to whom the report is issued may, however, show or send it . or a certified copy there of prepared by the SHENZHEN TIMEWAY TESTING LABORATORIES. to his customer. Supplier or others persons directly concerned. SHENZHEN TIMEWAY TESTING LABORATORIES. will not, without the consent of the client enter into any discussion of correspondence with any third party concerning the contents of the report.  
In the event of the improper use of the report. The SHENZHEN TIMEWAY TESTING LABORATORIES. reserves the rights to withdraw it and to adopt any other remedies which may be appropriate.



**5.6 Power-Frequency magnetic field test**

**5.6.1 Schematics of the test**



**5.6.2 Test Method**

The test was performed in accordance with EN 61000-4-8:2010

Severity: Level 1 (1A/m),

Performance Criterion Require: A (Please see following table)

**Block diagram of Test setup**

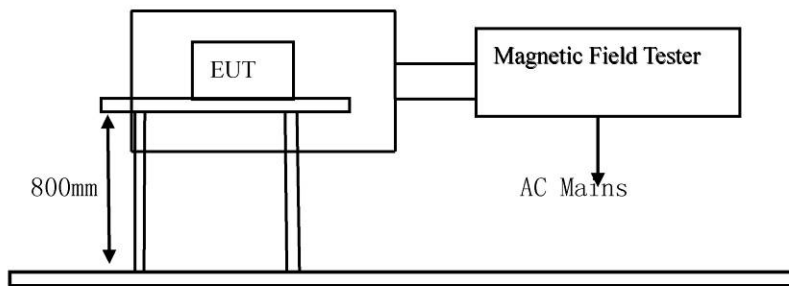

**5.6.3 Susceptibility performance Criteria and Severity Level**

Susceptibility performance Criteria

Criterion	Description
<b>A</b>	No change in operational mode or degradation of performance outside of specification and no change in stored parameters.
<b>B</b>	Degradation of performance allowed during the test the EUT returning to intended operation after the test.
<b>C</b>	Loss of function allowed during the test, provided that function is self recoverable or can be recovered by operation of controls.

Severity Level

Severity Level	Magnetic Field Strength A/m
1	1
2	3
3	10
4	30
5	100
*	Special

The report refers only to the sample tested and does not apply to the bulk.

This report is issued in confidence to the client and it will be strictly treated as such by the SHENZHEN TIMEWAY TESTING LABORATORIES. It may not be reproduced rather in its entirety or in part and it may not be used for advertising. The client to whom the report is issued may, however, show or send it . or a certified copy there of prepared by the SHENZHEN TIMEWAY TESTING LABORATORIES. to his customer. Supplier or others persons directly concerned. SHENZHEN TIMEWAY TESTING LABORATORIES. will not, without the consent of the client enter into any discussion of correspondence with any third party concerning the contents of the report.

In the event of the improper use of the report. The SHENZHEN TIMEWAY TESTING LABORATORIES. reserves the rights to withdraw it and to adopt any other remedies which may be appropriate.



**5.6.4 Test Results:**

**EUT Operating Environment**

Temperature: 25°C      Humidity: 75%RH      Atmospheric Pressure: 101 kPa

Please refer to the following table for individual results.

Test Level	Testing Duration	Coil Orientation	Criterion	Result
1A/m	5 Mins	X	A	N/A
1A/m	5 Mins	Y	A	N/A
1A/m	5 Mins	Z	A	N/A

The report refers only to the sample tested and does not apply to the bulk.  
This report is issued in confidence to the client and it will be strictly treated as such by the SHENZHEN TIMEWAY TESTING LABORATORIES. It may not be reproduced rather in its entirety or in part and it may not be used for advertising. The client to whom the report is issued may, however, show or send it . or a certified copy there of prepared by the SHENZHEN TIMEWAY TESTING LABORATORIES. to his customer. Supplier or others persons directly concerned. SHENZHEN TIMEWAY TESTING LABORATORIES. will not, without the consent of the client enter into any discussion of correspondence with any third party concerning the contents of the report.  
In the event of the improper use of the report. The SHENZHEN TIMEWAY TESTING LABORATORIES. reserves the rights to withdraw it and to adopt any other remedies which may be appropriate.



**5.7 Voltage Dips/Interruptions immunity test**

**5.7.1 Schematics of the test**



**5.7.2 Test Method:**

The test was performed in accordance with EN 61000-4-11:2011

Performance Criterion Require: C&B (Please see following table)

**Block diagram of Test setup**

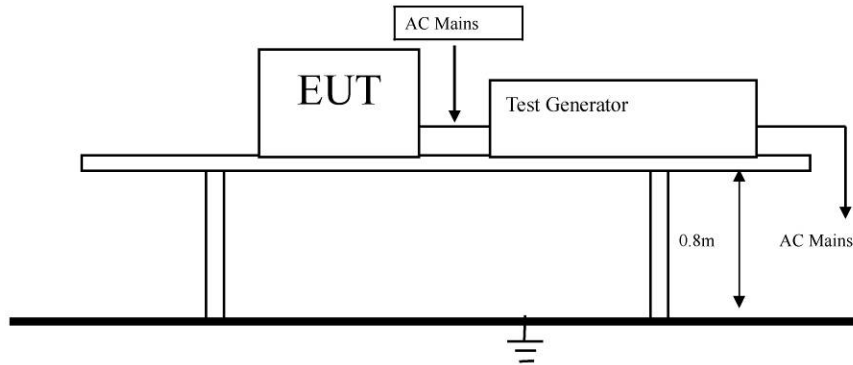

**5.7.3 Susceptibility performance Criteria and Severity Level**

Susceptibility performance Criteria

Criterion	Description
<b>A</b>	No change in operational mode or degradation of performance outside of specification and no change in stored parameters.
<b>B</b>	Degradation of performance allowed during the test the EUT returning to intended operation after the test.
<b>C</b>	Loss of function allowed during the test, provided that function is self recoverable or can be recovered by operation of controls.

The report refers only to the sample tested and does not apply to the bulk.  
 This report is issued in confidence to the client and it will be strictly treated as such by the SHENZHEN TIMEWAY TESTING LABORATORIES. It may not be reproduced rather in its entirety or in part and it may not be used for advertising. The client to whom the report is issued may, however, show or send it . or a certified copy there of prepared by the SHENZHEN TIMEWAY TESTING LABORATORIES. to his customer. Supplier or others persons directly concerned. SHENZHEN TIMEWAY TESTING LABORATORIES. will not, without the consent of the client enter into any discussion of correspondence with any third party concerning the contents of the report.  
 In the event of the improper use of the report. The SHENZHEN TIMEWAY TESTING LABORATORIES. reserves the rights to withdraw it and to adopt any other remedies which may be appropriate.



Severity Level

Voltage Dip	Test Level %Ut	Reduction	Duration (Periods)	Performance Criteria
	<5	>95	0.5	B
	70	30	25	C
Voltage Interceptions	Test Level %Ut	Reduction	Duration (Periods)	Performance Criteria
	<5	>95	250	C

**5.7.4 Test Result:**

**EUT Operating Environment**

Temperature: 25°C      Humidity: 75%RH      Atmospheric Pressure: 101 kPa

Please refer to the following table for individual results.

Voltage Dip:

Test Level % Ut	Reduction	Duration (periods)	Phase Angle	Meet Criterion	Result
0	100	0.5	0° - 360°	B	Pass
70	30	25	0° - 360°	C	Pass

Voltage Interceptions:

Test Level % Ut	Reduction	Duration (periods)	Phase Angle	Meet Criterion	Result
0	100	250	0° - 360°	C	Pass

The report refers only to the sample tested and does not apply to the bulk.

This report is issued in confidence to the client and it will be strictly treated as such by the SHENZHEN TIMEWAY TESTING LABORATORIES. It may not be reproduced rather in its entirety or in part and it may not be used for advertising. The client to whom the report is issued may, however, show or send it . or a certified copy there of prepared by the SHENZHEN TIMEWAY TESTING LABORATORIES. to his customer. Supplier or others persons directly concerned. SHENZHEN TIMEWAY TESTING LABORATORIES. will not, without the consent of the client enter into any discussion of correspondence with any third party concerning the contents of the report.

In the event of the improper use of the report. The SHENZHEN TIMEWAY TESTING LABORATORIES. reserves the rights to withdraw it and to adopt any other remedies which may be appropriate.



## 6.0 Product Labelling

### 6.1 CE Mark label specification

Text of the mark is black or white in color and is left justified. Labels are printed in indelible ink on permanent adhesive backing and shall be affixed at a conspicuous location on the EUT or silk-screened onto the EUT.



### 6.2 Mark Location: Rear enclosure

The report refers only to the sample tested and does not apply to the bulk.  
This report is issued in confidence to the client and it will be strictly treated as such by the SHENZHEN TIMEWAY TESTING LABORATORIES. It may not be reproduced rather in its entirety or in part and it may not be used for advertising. The client to whom the report is issued may, however, show or send it . or a certified copy there of prepared by the SHENZHEN TIMEWAY TESTING LABORATORIES. to his customer. Supplier or others persons directly concerned. SHENZHEN TIMEWAY TESTING LABORATORIES. will not, without the consent of the client enter into any discussion of correspondence with any third party concerning the contents of the report.  
In the event of the improper use of the report. The SHENZHEN TIMEWAY TESTING LABORATORIES. reserves the rights to withdraw it and to adopt any other remedies which may be appropriate.



Appendix:

Conducted Emissions

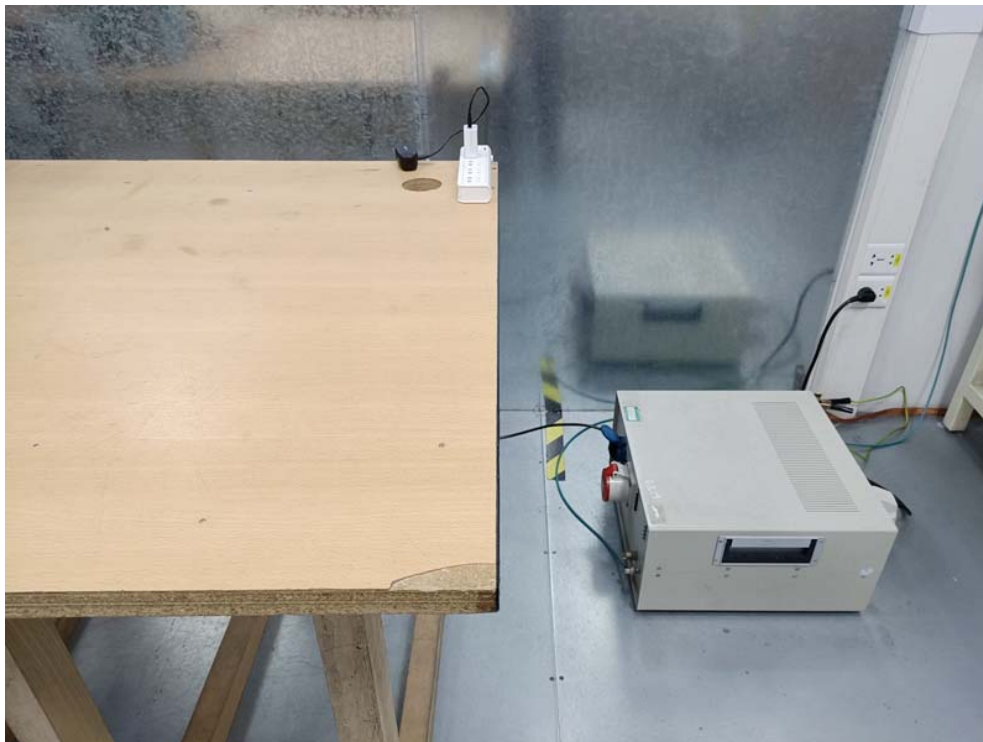

The report refers only to the sample tested and does not apply to the bulk.  
This report is issued in confidence to the client and it will be strictly treated as such by the SHENZHEN TIMEWAY TESTING LABORATORIES. It may not be reproduced rather in its entirety or in part and it may not be used for advertising. The client to whom the report is issued may, however, show or send it . or a certified copy there of prepared by the SHENZHEN TIMEWAY TESTING LABORATORIES. to his customer. Supplier or others persons directly concerned. SHENZHEN TIMEWAY TESTING LABORATORIES. will not, without the consent of the client enter into any discussion of correspondence with any third party concerning the contents of the report.  
In the event of the improper use of the report. The SHENZHEN TIMEWAY TESTING LABORATORIES. reserves the rights to withdraw it and to adopt any other remedies which may be appropriate.



### Radiated Emissions

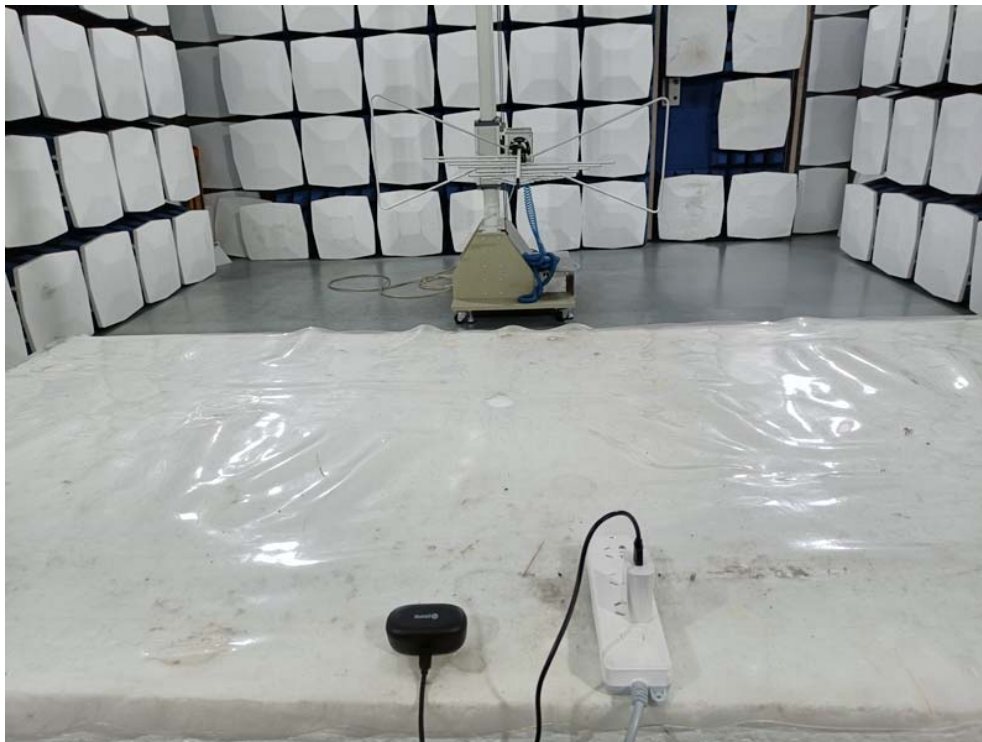

The report refers only to the sample tested and does not apply to the bulk.  
This report is issued in confidence to the client and it will be strictly treated as such by the SHENZHEN TIMEWAY TESTING LABORATORIES. It may not be reproduced rather in its entirety or in part and it may not be used for advertising. The client to whom the report is issued may, however, show or send it . or a certified copy there of prepared by the SHENZHEN TIMEWAY TESTING LABORATORIES. to his customer. Supplier or others persons directly concerned. SHENZHEN TIMEWAY TESTING LABORATORIES. will not, without the consent of the client enter into any discussion of correspondence with any third party concerning the contents of the report.  
In the event of the improper use of the report. The SHENZHEN TIMEWAY TESTING LABORATORIES. reserves the rights to withdraw it and to adopt any other remedies which may be appropriate.



Outside View - charger base



The report refers only to the sample tested and does not apply to the bulk.  
This report is issued in confidence to the client and it will be strictly treated as such by the SHENZHEN TIMEWAY TESTING LABORATORIES. It may not be reproduced rather in its entirety or in part and it may not be used for advertising. The client to whom the report is issued may, however, show or send it . or a certified copy there of prepared by the SHENZHEN TIMEWAY TESTING LABORATORIES. to his customer. Supplier or others persons directly concerned. SHENZHEN TIMEWAY TESTING LABORATORIES. will not, without the consent of the client enter into any discussion of correspondence with any third party concerning the contents of the report.  
In the event of the improper use of the report. The SHENZHEN TIMEWAY TESTING LABORATORIES. reserves the rights to withdraw it and to adopt any other remedies which may be appropriate.



Outside View - charger base



The report refers only to the sample tested and does not apply to the bulk.  
This report is issued in confidence to the client and it will be strictly treated as such by the SHENZHEN TIMEWAY TESTING LABORATORIES. It may not be reproduced rather in its entirety or in part and it may not be used for advertising. The client to whom the report is issued may, however, show or send it . or a certified copy there of prepared by the SHENZHEN TIMEWAY TESTING LABORATORIES. to his customer. Supplier or others persons directly concerned. SHENZHEN TIMEWAY TESTING LABORATORIES. will not, without the consent of the client enter into any discussion of correspondence with any third party concerning the contents of the report.  
In the event of the improper use of the report. The SHENZHEN TIMEWAY TESTING LABORATORIES. reserves the rights to withdraw it and to adopt any other remedies which may be appropriate.

Outside View - charger base



The report refers only to the sample tested and does not apply to the bulk.  
This report is issued in confidence to the client and it will be strictly treated as such by the SHENZHEN TIMEWAY TESTING LABORATORIES. It may not be reproduced rather in its entirety or in part and it may not be used for advertising. The client to whom the report is issued may, however, show or send it . or a certified copy there of prepared by the SHENZHEN TIMEWAY TESTING LABORATORIES. to his customer. Supplier or others persons directly concerned. SHENZHEN TIMEWAY TESTING LABORATORIES. will not, without the consent of the client enter into any discussion of correspondence with any third party concerning the contents of the report.  
In the event of the improper use of the report. The SHENZHEN TIMEWAY TESTING LABORATORIES. reserves the rights to withdraw it and to adopt any other remedies which may be appropriate.



Outside View - charger base



The report refers only to the sample tested and does not apply to the bulk.

This report is issued in confidence to the client and it will be strictly treated as such by the SHENZHEN TIMEWAY TESTING LABORATORIES. It may not be reproduced rather in its entirety or in part and it may not be used for advertising. The client to whom the report is issued may, however, show or send it . or a certified copy there of prepared by the SHENZHEN TIMEWAY TESTING LABORATORIES. to his customer. Supplier or others persons directly concerned. SHENZHEN TIMEWAY TESTING LABORATORIES. will not, without the consent of the client enter into any discussion of correspondence with any third party concerning the contents of the report.

In the event of the improper use of the report. The SHENZHEN TIMEWAY TESTING LABORATORIES. reserves the rights to withdraw it and to adopt any other remedies which may be appropriate.



Inside View - charger base



The report refers only to the sample tested and does not apply to the bulk.  
This report is issued in confidence to the client and it will be strictly treated as such by the SHENZHEN TIMEWAY TESTING LABORATORIES. It may not be reproduced rather in its entirety or in part and it may not be used for advertising. The client to whom the report is issued may, however, show or send it . or a certified copy there of prepared by the SHENZHEN TIMEWAY TESTING LABORATORIES. to his customer. Supplier or others persons directly concerned. SHENZHEN TIMEWAY TESTING LABORATORIES. will not, without the consent of the client enter into any discussion of correspondence with any third party concerning the contents of the report.  
In the event of the improper use of the report. The SHENZHEN TIMEWAY TESTING LABORATORIES. reserves the rights to withdraw it and to adopt any other remedies which may be appropriate.

Inside View - charger base

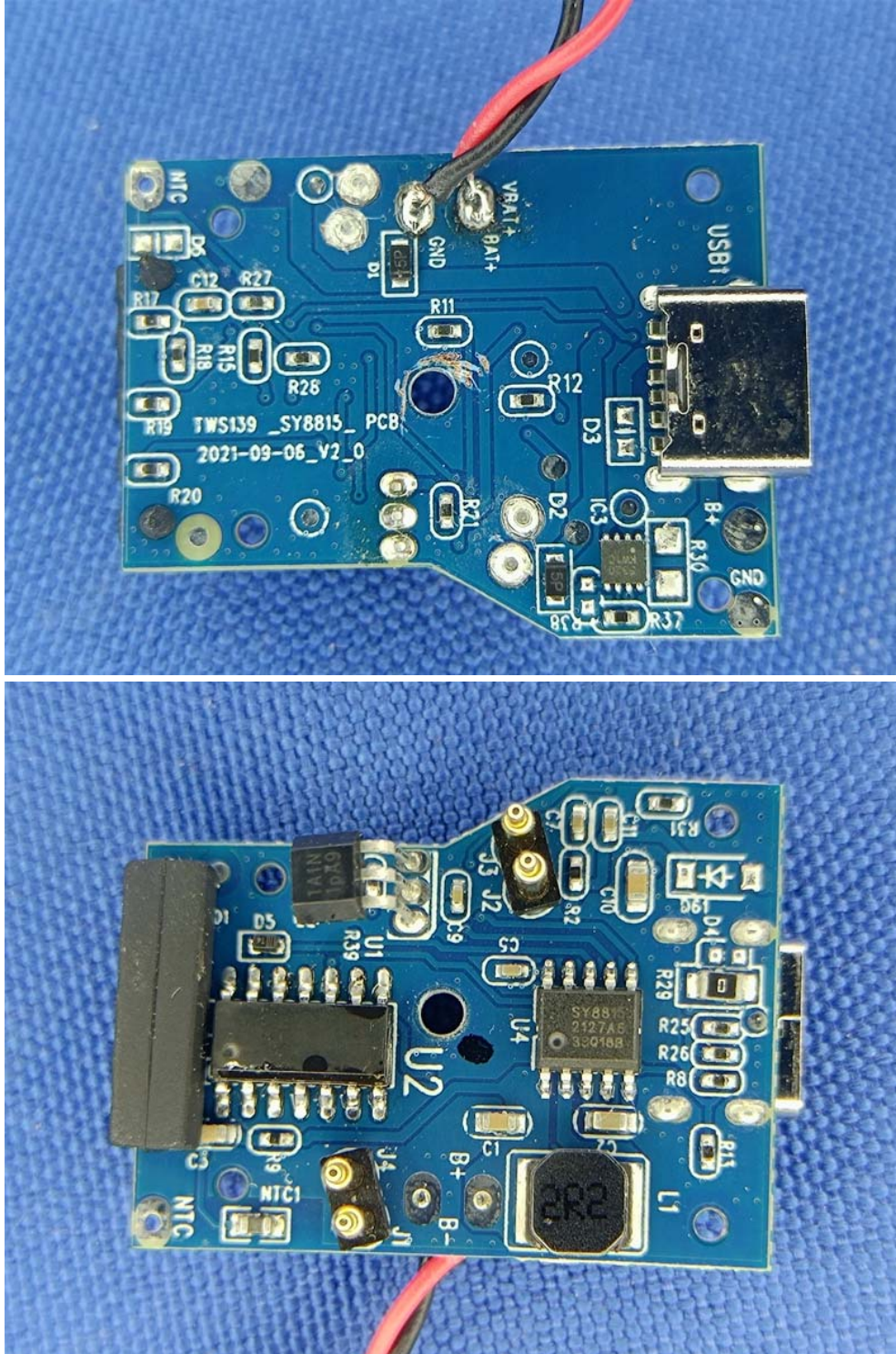

The report refers only to the sample tested and does not apply to the bulk.  
This report is issued in confidence to the client and it will be strictly treated as such by the SHENZHEN TIMEWAY TESTING LABORATORIES. It may not be reproduced rather in its entirety or in part and it may not be used for advertising. The client to whom the report is issued may, however, show or send it . or a certified copy there of prepared by the SHENZHEN TIMEWAY TESTING LABORATORIES. to his customer. Supplier or others persons directly concerned. SHENZHEN TIMEWAY TESTING LABORATORIES. will not, without the consent of the client enter into any discussion of correspondence with any third party concerning the contents of the report.  
In the event of the improper use of the report. The SHENZHEN TIMEWAY TESTING LABORATORIES. reserves the rights to withdraw it and to adopt any other remedies which may be appropriate.



Outside View - Left earphone



The report refers only to the sample tested and does not apply to the bulk.  
This report is issued in confidence to the client and it will be strictly treated as such by the SHENZHEN TIMEWAY TESTING LABORATORIES. It may not be reproduced rather in its entirety or in part and it may not be used for advertising. The client to whom the report is issued may, however, show or send it . or a certified copy there of prepared by the SHENZHEN TIMEWAY TESTING LABORATORIES. to his customer. Supplier or others persons directly concerned. SHENZHEN TIMEWAY TESTING LABORATORIES. will not, without the consent of the client enter into any discussion of correspondence with any third party concerning the contents of the report.  
In the event of the improper use of the report. The SHENZHEN TIMEWAY TESTING LABORATORIES. reserves the rights to withdraw it and to adopt any other remedies which may be appropriate.



Outside View - Left earphone



The report refers only to the sample tested and does not apply to the bulk.  
This report is issued in confidence to the client and it will be strictly treated as such by the SHENZHEN TIMEWAY TESTING LABORATORIES. It may not be reproduced rather in its entirety or in part and it may not be used for advertising. The client to whom the report is issued may, however, show or send it . or a certified copy there of prepared by the SHENZHEN TIMEWAY TESTING LABORATORIES. to his customer. Supplier or others persons directly concerned. SHENZHEN TIMEWAY TESTING LABORATORIES. will not, without the consent of the client enter into any discussion of correspondence with any third party concerning the contents of the report.  
In the event of the improper use of the report. The SHENZHEN TIMEWAY TESTING LABORATORIES. reserves the rights to withdraw it and to adopt any other remedies which may be appropriate.

Inside View - Left earphone

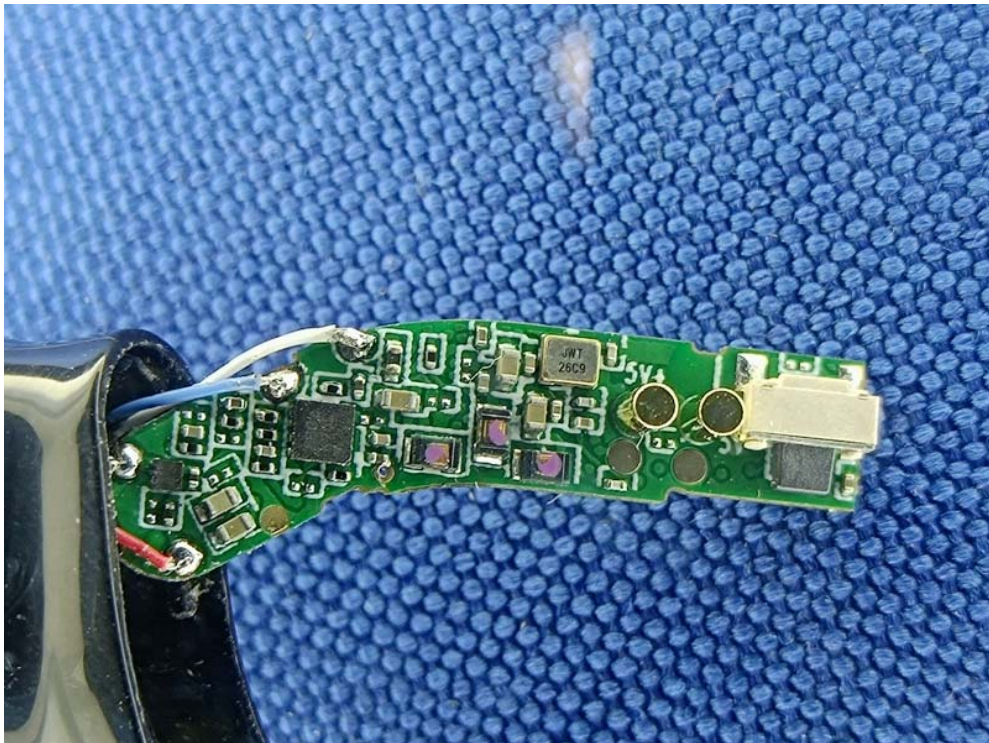
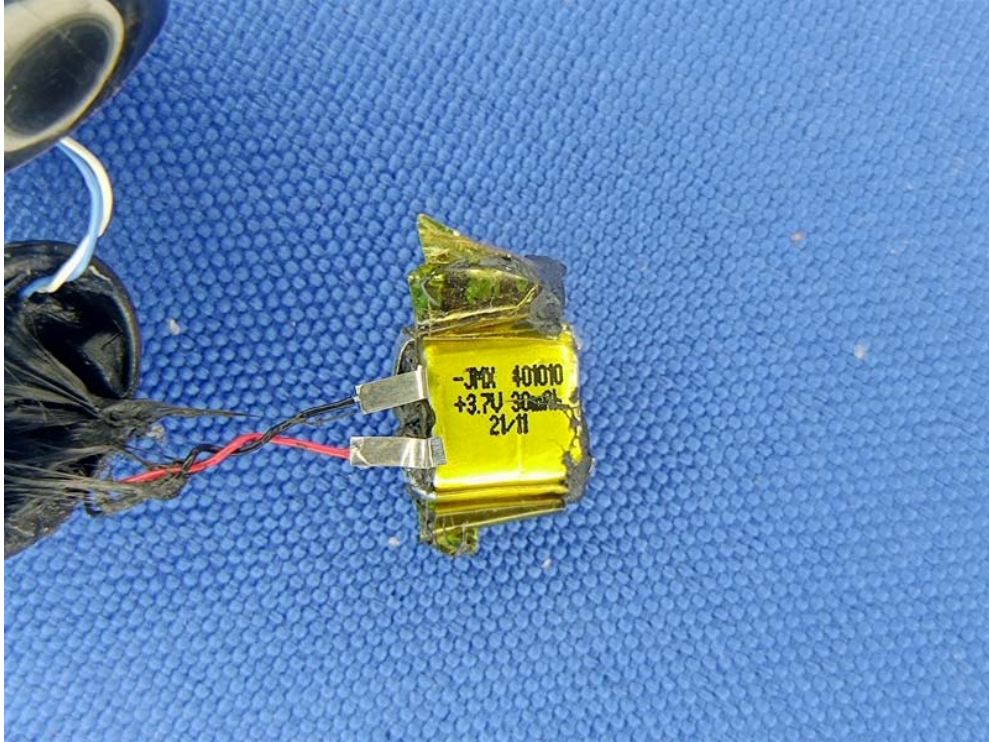

The report refers only to the sample tested and does not apply to the bulk.  
This report is issued in confidence to the client and it will be strictly treated as such by the SHENZHEN TIMEWAY TESTING LABORATORIES. It may not be reproduced rather in its entirety or in part and it may not be used for advertising. The client to whom the report is issued may, however, show or send it . or a certified copy there of prepared by the SHENZHEN TIMEWAY TESTING LABORATORIES. to his customer. Supplier or others persons directly concerned. SHENZHEN TIMEWAY TESTING LABORATORIES. will not, without the consent of the client enter into any discussion of correspondence with any third party concerning the contents of the report.  
In the event of the improper use of the report. The SHENZHEN TIMEWAY TESTING LABORATORIES. reserves the rights to withdraw it and to adopt any other remedies which may be appropriate.



Inside View - Left earphone

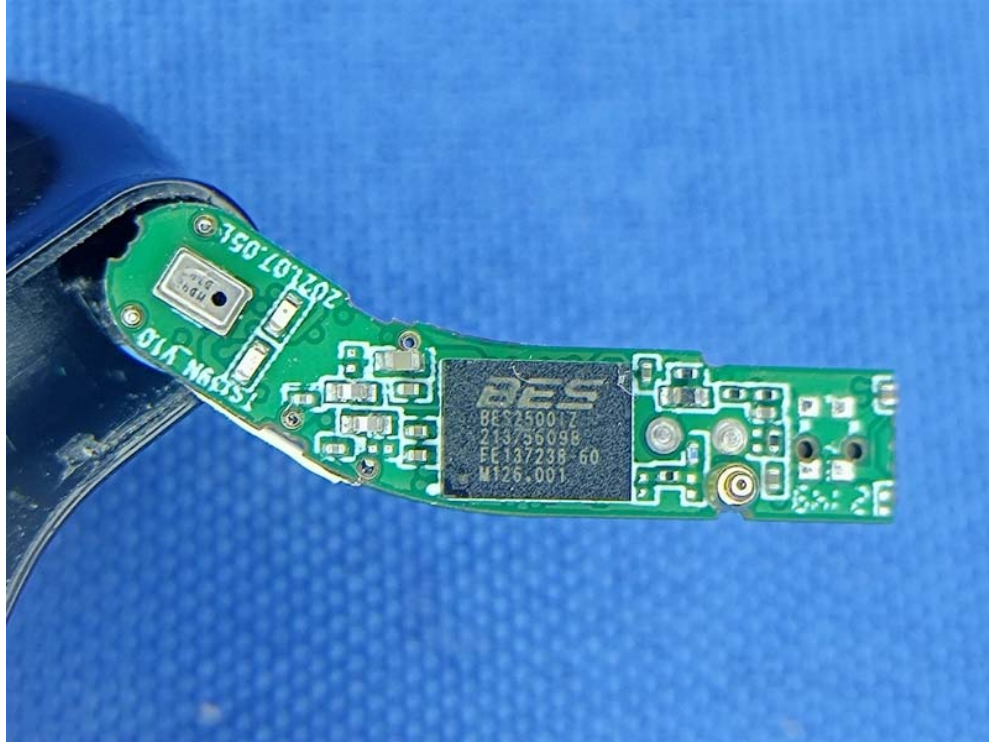

The report refers only to the sample tested and does not apply to the bulk.

This report is issued in confidence to the client and it will be strictly treated as such by the SHENZHEN TIMEWAY TESTING LABORATORIES. It may not be reproduced rather in its entirety or in part and it may not be used for advertising. The client to whom the report is issued may, however, show or send it . or a certified copy there of prepared by the SHENZHEN TIMEWAY TESTING LABORATORIES. to his customer. Supplier or others persons directly concerned. SHENZHEN TIMEWAY TESTING LABORATORIES. will not, without the consent of the client enter into any discussion of correspondence with any third party concerning the contents of the report.

In the event of the improper use of the report. The SHENZHEN TIMEWAY TESTING LABORATORIES. reserves the rights to withdraw it and to adopt any other remedies which may be appropriate.



Outside View - Right earphone



The report refers only to the sample tested and does not apply to the bulk.  
This report is issued in confidence to the client and it will be strictly treated as such by the SHENZHEN TIMEWAY TESTING LABORATORIES. It may not be reproduced rather in its entirety or in part and it may not be used for advertising. The client to whom the report is issued may, however, show or send it . or a certified copy there of prepared by the SHENZHEN TIMEWAY TESTING LABORATORIES. to his customer. Supplier or others persons directly concerned. SHENZHEN TIMEWAY TESTING LABORATORIES. will not, without the consent of the client enter into any discussion of correspondence with any third party concerning the contents of the report.  
In the event of the improper use of the report. The SHENZHEN TIMEWAY TESTING LABORATORIES. reserves the rights to withdraw it and to adopt any other remedies which may be appropriate.



Outside View - Right earphone



The report refers only to the sample tested and does not apply to the bulk.  
This report is issued in confidence to the client and it will be strictly treated as such by the SHENZHEN TIMEWAY TESTING LABORATORIES. It may not be reproduced rather in its entirety or in part and it may not be used for advertising. The client to whom the report is issued may, however, show or send it . or a certified copy there of prepared by the SHENZHEN TIMEWAY TESTING LABORATORIES. to his customer. Supplier or others persons directly concerned. SHENZHEN TIMEWAY TESTING LABORATORIES. will not, without the consent of the client enter into any discussion of correspondence with any third party concerning the contents of the report.  
In the event of the improper use of the report. The SHENZHEN TIMEWAY TESTING LABORATORIES. reserves the rights to withdraw it and to adopt any other remedies which may be appropriate.



Inside View - Right earphone

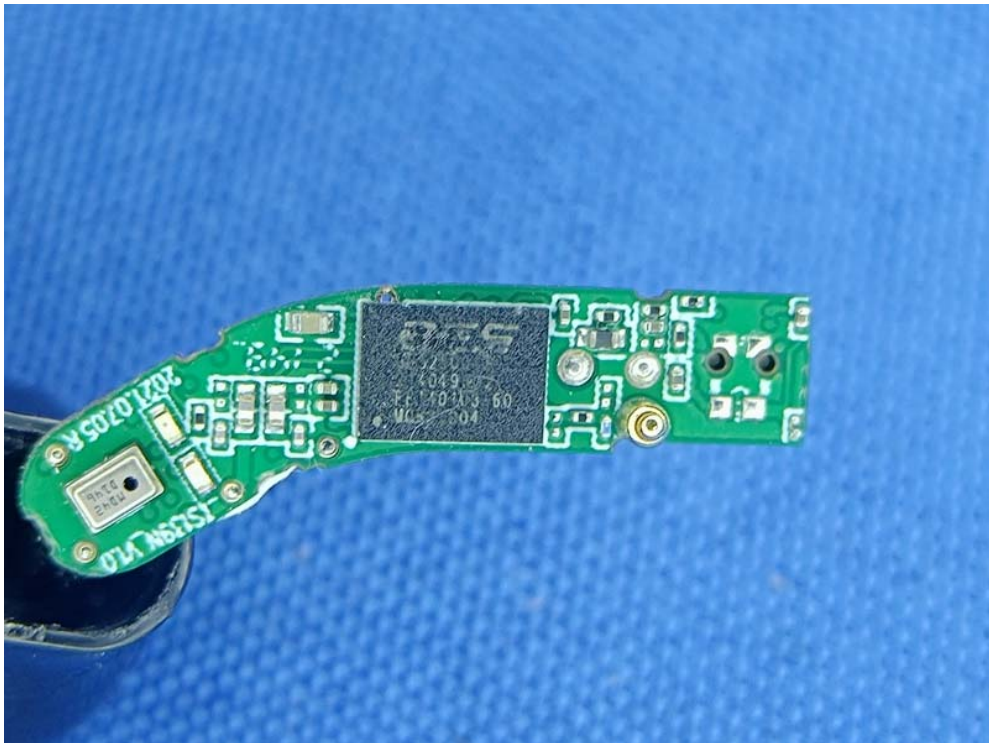
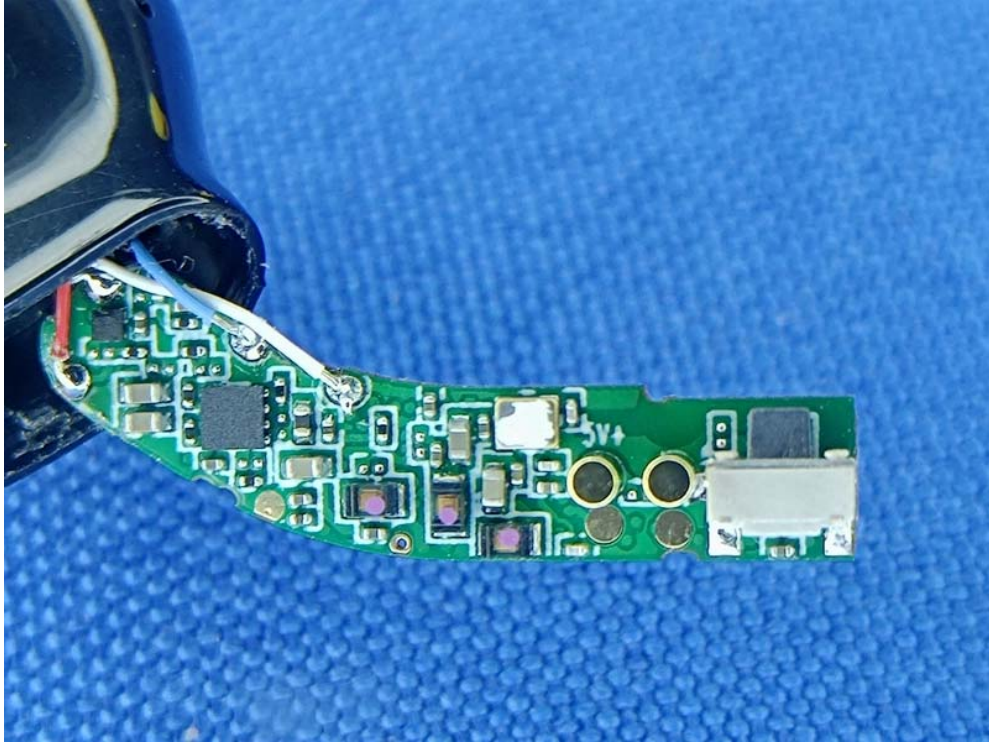

**-End of the report-**

The report refers only to the sample tested and does not apply to the bulk.  
This report is issued in confidence to the client and it will be strictly treated as such by the SHENZHEN TIMEWAY TESTING LABORATORIES. It may not be reproduced rather in its entirety or in part and it may not be used for advertising. The client to whom the report is issued may, however, show or send it . or a certified copy there of prepared by the SHENZHEN TIMEWAY TESTING LABORATORIES. to his customer. Supplier or others persons directly concerned. SHENZHEN TIMEWAY TESTING LABORATORIES. will not, without the consent of the client enter into any discussion of correspondence with any third party concerning the contents of the report.  
In the event of the improper use of the report. The SHENZHEN TIMEWAY TESTING LABORATORIES. reserves the rights to withdraw it and to adopt any other remedies which may be appropriate.